



[ipmscanada.com](http://ipmscanada.com)

**- RCAF Mustang Mk.I Addendum -**  
A selection of articles from past issues of RT



## **Mustang Addendum (June 2013) Contents**

- **Page 4 - Mustang I Profiles, RT 32/3**
- **Page 6 - 1/48 Mustang Mk. I - Part 1-, by Bruce Archer, RT 32/3**
- **Page 12 - 1/48 Mustang Mk. I - Part 2 -, by Gary Barling, RT 32/3**
- **Page 16 - The First Mustang, by Bill Coffman, RT 24/1**
- **Page 19 - Mustang I AM251 / 'O', 414 Squadron, by Steve Sauv , RT 24/1**
- **Page 25 - North American Mustang I, by Cam Harris, RT 24/3**

# RCAF Mustang I Profiles

## AM251, 'O'

with 414 Sqn Sep 42 - Jun 44  
Pilot: F/Lt G. Burroughs, DFC

"Pistol Packin' Momma"  
removed before D-Day

Oblique camera fitted

24" x 24" fin flash  
on AM251



Yellow wing leading edge strips on AM251 end just outboard of wing guns.

AM251 markings scheme shown in the period **post-Sep 43** and **pre-D-Day**. Rudder was regular camouflage in May 43.

DTD-C 83A refers to paint finish specification on AM251

Prop blade roots on AM251 show Sky overspray, from spinner being painted after delivery in UK

**Mustang I Colour Scheme:**  
Dark Green and Ocean Grey or Mixed Grey over Medium Sea Grey. 18" Tail band and spinner are Sky

Replacement rudder fitted circa Sep 43. Solid dark colour (US Olive Drab?)

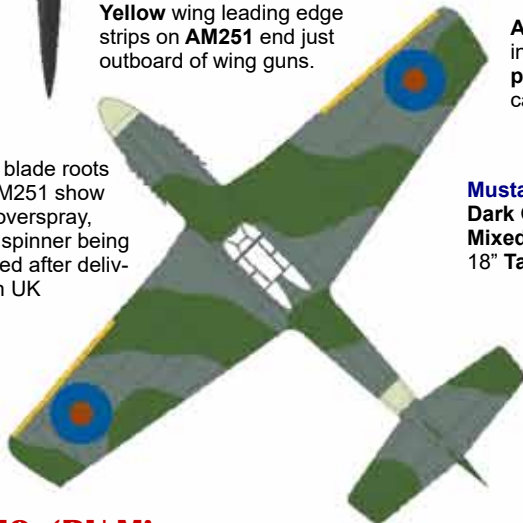

**National Markings:**  
Upper Wings - 40" Type B  
Lower Wings - 32" Type C  
Fuselage - 36" Type C1  
Fin Flash - as indicated

Fin flash on AG470 could be 24" x 24" or 24" x 27" high

## AG470, 'RU-M'

with 414 Sqn Jun 42 - Dec 42  
Pilot: P/O Hollis Hills

Camera not fitted to AG470 circa Dieppe operation

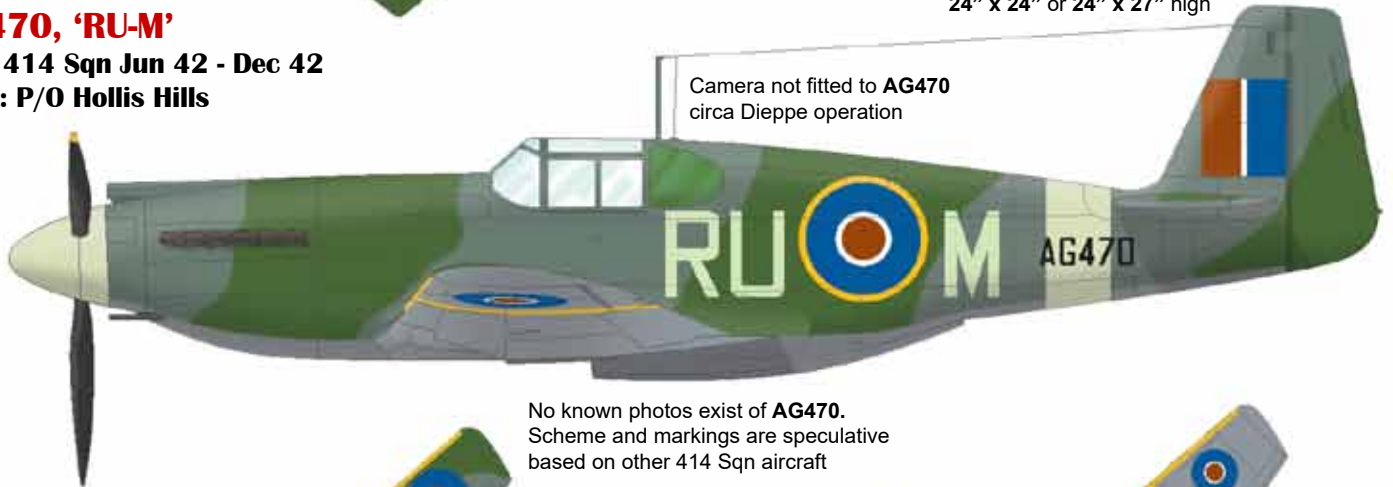

No known photos exist of AG470. Scheme and markings are speculative based on other 414 Sqn aircraft

Yellow wing leading edge strips on AG470 are speculative. Some Mustang I photos show **full span strips**; others show them ending **just outboard of wing guns**.

12" wide Yellow identification bands probably carried on wings of AG470. These may have been reduced to 6" prior to complete removal in Dec '42

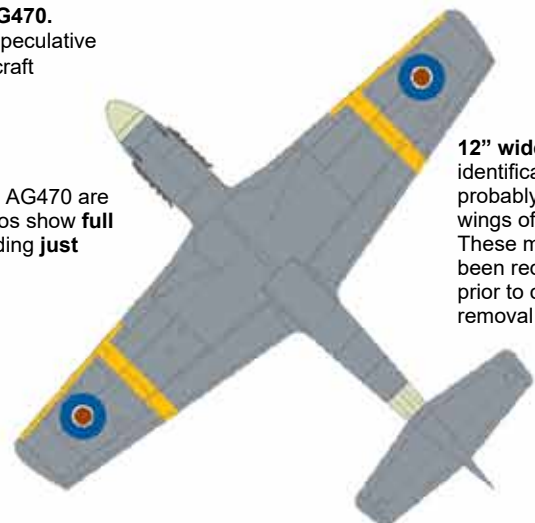
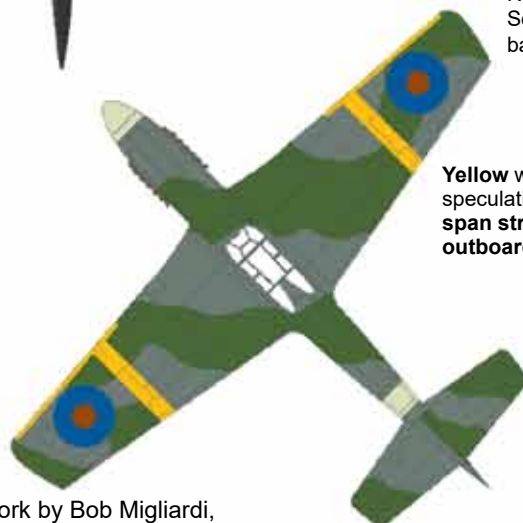

Artwork by Bob Migliardi,  
Notes by Steve Sauvé, July 2010



# Notes for RCAF Mustang Mk.I Profiles

## AG470 Service History

**26 Feb 42** Shipped from USA to Lockheed Abbotsinch for re-assembly

**11 Jun 42** 414 Sqn

**23 Dec 42** 240 hr. Inspection at A.T. Oxford

**08 Feb 43** 51 MU

**18 Aug 44** 38 MU

**13 Mar 47** Stuck Off Charge (SOC)

## AG470 Marking Notes

AG470, RU-M, circa August 1942. No nose art or RCAF Roundel applied. No oblique camera fitted.

No known photos of AG470 in 414's hands, so the scheme and markings presented are a best guess, based on photos of other 414 Sqn aircraft and the marking practices in effect at the time of OPERATION JUBILEE, the Dieppe landing operation on 19 Aug 42.

## AM251 Service History

**18 Jan 42** USA to UK

**29 Jul 42** Abbotsinch Lockheed

**06 Sep 42** 414 Sqn

**31 May 43** 414 Sqn

**20 Mar 44** Battle Damage Cat. AC

**06 Apr 44** 49 MU

**15 Jun 44** 414 Sqn

**19 Jun 44** Missing in action

## AM251 Marking Notes

Nose Art and colour scheme evolution (confirmed from several period photos of 'O', except as noted)

- **May '43** – RCAF Roundel, with original Grey and Green rudder. Paint finish is in good condition with no heavy weathering evident.

- **Sep '43** – RCAF Roundel and Mustang head, with replacement rudder painted in a solid dark colour. May have been fresh MAP Dark Green, or US Olive Drab. Much weathering in evidence.

Photo of a genuine unused 8" decal of the RCAF overseas operational emblem, approved for use from March 1943. From the John Griffin collection, held at the History & Heritage Archives at 1 Cdn Air Div HQ in Winnipeg. Note that reddish discoloration around marking was present on the decal backing paper. Photo by Steve Sauvé, October 2008



- **Feb '44** – RCAF Roundel, Mustang head, "Pistol Packin Momma" carried at this time. Noticeable weathering is visible. Based on paint pattern 'landmarks', the paint job dates from Sep 43

- **Jun '44** – RCAF Roundel, Mustang head (George Burroughs, AM251's regular pilot, believes that "Pistol Packin' Momma" was removed prior to D-Day)

## General Notes

All Mustang Is delivered to Britain were painted in Brown/Green/Sky Gray, DuPont's 'equivalents' of British MAP colours for the Temperate Land Scheme, with brown spinners. Therefore both aircraft illustrated were repainted, or at least partially repainted, into the Day Fighter Scheme in the UK. The RAF Day Fighter Scheme was introduced in August 1941. This consisted of Dark Green and 'Mixed Grey' or Ocean Grey on the upper surfaces, with Medium Sea Grey lower surfaces.

So-called 'Mixed Grey' was the original formula for what was later named Ocean Grey. It was created by mixing seven parts Medium Sea Grey and one part Night (which is not a pure Black; it has a bluish tone). Photo evidence of the period shows a wide variety of shades resulted from this mixing.

Depending on who you're reading, Mixed Grey was either:

- the first colour 'spec'd' for the Day Fighter Scheme, and it was superseded by the new colour, Ocean Grey, or
- introduced due to a shortage of Ocean Grey

If you want to visit a really great blog site that very intelligently discusses the field of American paint on aircraft supplied to the RAF, you must check out this site run by Nick Millman:

<http://amair4raf.blogspot.com/2009/01/welcome-to-amair4raf.html>

The RCAF Overseas operational roundel decals were not in use until after Mar '43; RU-M could not have carried it during the Dieppe operation in Aug '42.



One modeller's idea of how to build a 1/48 Allison-Powered Mustang, flown by P/O Hollis Hills, 414 Sqn, RCAF, Dieppe, 1942...

# 1/48 RCAF Mustang Mk. I - Part 1 -

by **Bruce Archer**  
IPMS Canada C#3195  
IPMS Orlando  
Kissimmee, Florida, USA



## INTRODUCTION

Through the years I have been reading model magazines and on various modelling web sites, and I have been amazed by very obvious mistakes and the lack of basic research. Landing gear on backwards, wrong colours and even chronological anomalies have been printed or posted. Even very well-known aircraft are not safe from these *faux pas*.

Everyone knows how to do a Mustang, right? Not really, as Tom Cleaver on Modeling Madness felt moved to do a 'How to' for Merlin Mustangs. The Allison Mustang is even more poorly represented, as several very common, and easily corrected, mistakes continue to appear. That is the thrust of this article, not to super detail an Allison Mustang, rather to correct several of the more glaring errors in the 1/48 scale Accurate Miniatures kit, and to point out some of the more common build-

ing errors with the Allison Mustang.

## THE MUSTANG'S GENESIS

When Adolph Hitler enacted the ancestry race laws in Nazi Germany, he forced a young aircraft designer to leave Germany and move to the USA. This single act was the final nail that would eventually condemn the Luftwaffe in WWII. The engineer soon found work at an up-and-coming company by the name of North American (NA). It was here that Edgar Schmued, who had been working for Messerschmitt, and did a lot of the detail design of the Bf 109, was able to continue designing 'his' fighter. He teamed up with 'Dutch' Kindelberger and the fighter rapidly took form. Schmued used the latest information from Europe, and the latest aeronautical data. His fighter was equipped with a laminar flow wing, and used the 'Meredith Effect' to eliminate the drag of the radiator and scoop. NA purchased data from Curtiss pertaining to the 'advanced' XP-46 project ([http://en.wikipedia.org/wiki/Curtiss\\_XP-46](http://en.wikipedia.org/wiki/Curtiss_XP-46)). The data was found to be useless to NA's needs as the Mustang design was already

### List of Items Used

**Accurate Miniatures** Kit 3410, RAF Mustang IA

#### Ultracast:

48031 Mustang I Conversion  
48014 Early Production P-51 Seat  
48070 Early Mustang Flared Exhaust

**Eduard** Part B-6, from a P-39/P-400 kit

**Arrow Graphics** D-35-48 Pilot Officer Hollis Hills' Mustang I at Dieppe

**Aeromaster Decals** No. 48-106 "Early Mustangs"

more advanced than the XP-46.

All that North American needed was a source of funds to build Schmued's fighter. When the British Purchasing Commission (BPC) approached North American to build P-40s for the RAF, NA jumped at the chance to have the BPC and the RAF pay the final development costs for their new fighter. Final detail work, production

drawings and the cutting of metal took 120 days and the first Mustang was rolled out, on T-6 Texan wheels and minus an engine. Thus, the Mustang was born, and, when eventually fitted with the superb Rolls-Royce Merlin, evolved into the best long-range escort/air superiority fighter of WWII, but that story is for another time.

The Mustang was originally equipped with a GM Allison V-1710 12 cylinder engine. The Achilles heel of this engine was its single stage, single speed supercharger.

## THE MUSTANG'S RECORD

So maybe you're thinking that the Allison Mustang wasn't a good aircraft? Nothing could be further from the truth. What the British got in the Mustang I was a magnificent low-level fighter. Below 15,000 feet it was one of, if not THE fastest fighters in the world. It had heavy armament (4 x 0.5" and 4 x 0.303" Browning machine guns), a good supply of ammo, and, importantly, lots of fuel for a long range (a detail now known as 'combat persistence'). Because of its altitude limitations, the RAF used the Mustang I for low-level armed recce ops, Army cooperation, and interdiction. The Mustang I soon replaced Tomahawks and Lysanders in the Army Cooperation role. RCAF Nos. 400 and 414 Squadrons re-equipped with the Mustang I in the late summer of 1942 and No. 430 Squadron re-equipped with the Mustang I in the spring of 1943. The only Allison Mustang the RCAF flew operationally was the Mustang I. The Mustang started performing armed recce missions over the Continent, using the oblique camera mounted behind the pilot. By November of 1943, Nos. 400, 414, and 430 Squadrons became part of the 2nd Tactical Air Force (2TAF). By D-Day 430 Sqn had re-equipped with Spitfire FR Mk.XIV, and by 1945 both 400 and 414 Sqns had converted to other types.

How successful was the Mustang I in its roles? In 1944, the RAF started to convert Mustang I Squadrons to various marks of Spitfires, Mosquitos and Typhoons, but not because these aircraft were better; rather the RAF was simply running out of usable Allison Mustang airframes. The RAF tried to recover any Mustang crash, as spare parts were becoming a problem. There were at least 60 RAF Mustang Is in Squadron service at the war's end. After the war, the remaining Allison Mustangs were pulled from service.

## THE SUBJECT - AG470

The aircraft I modelled is Mustang I, AG470, **RUOM** of No. 414 Squadron,

RCAF, flown by Pilot Officer (P/O) Hollis Hills who had the first Mustang 'kill' during the OPERATION JUBILEE, the ill-fated Dieppe operation, on 19 August, 1942. Of course, everyone 'knows' that Hills' Mustang:

- ◆ was painted in Ocean Grey, Dark Green and Medium Sea Grey,
- ◆ wore Sky codes, tail band and spinner,
- ◆ carried the RCAF's maple leaf overseas emblem and sported a 'horse head' insignia.
- ◆ was equipped with an oblique camera pointed to port.

In researching the airframe (and information was being received as I was about to apply the decals) several conundrums became apparent. The first was the Ocean Grey. Most images of 414 Sqn's Mustangs indicate the colour was Mixed Grey. Mixed Grey was introduced due to a shortage of Ocean Grey, was (in the official formula, at least) prepared by mixing seven (7) parts Medium Sea Grey and one (1) part Night.

The leading edge ID stripes have been presented extending from the wing tip to the outer guns, and then inboard of the guns to the wing root. Looking at images it appears the ID stripe extended only to the outer guns.

The real surprise was that the Air Ministry in July of 1942, one month prior to Dieppe, said it was disappointed in the lack of progress in fitting cameras to Mustang type aircraft (*these were recorded minutes from a RAF/Air Ministry meeting. Cameras began to appear in Sqn aircraft about January of 1943, many thanks to Colin Ford for the minutes!*). Therefore Hollis Hills' Mustang was not fitted with a camera (*of course I found out after I fitted the camera!*).

Many artists have reproduced the aircraft having the RCAF's maple leaf overseas roundel decal and horse head. Again, most of the aircraft in 414 Sqn. did not have these items at Dieppe. So to sum this all up, Hills' Mustang was a Mk.I:

- ◆ with no camera,
- ◆ Mixed Grey, Dark Green, and Medium Sea Grey camo,
- ◆ with Sky band, codes, and spinner.
- ◆ The Maple Leaf and 'horse head' insignia were not carried.

## ALLISON MUSTANGS

There were a surprising number of Allison Mustang variants. Table No.1 gives more detail on the details of each variant, but here is a quick look at each.

**Mustang I** - The Mustang I was the first variant, **used exclusively by the RAF and RCAF**. It was armed with 2 x 0.5" cal. and 4 x 0.303" cal machine guns in the wings, and 2 x 0.5" cal. machine guns in the engine cowling 'cheeks'. All were delivered to the RAF (as were all Allison Mustangs) painted in:

- ◆ a dark green,
- ◆ a shade of brown, and
- ◆ a grey very close to the RAF/FAA shade 'Sky Grey' of American manufacture.

I have not been able to find out with certainty if these paints were produced by DuPont. The Mustang I had a narrow carb intake, a narrow chord Curtiss Electric three-bladed prop and an adjustable radiator intake. The Mustang I was able to carry both oblique and vertical cameras.

**Mustang IA** - Mustang I with 4 x 20 mm Hispano cannons replacing the machine guns.

**P-51** - US version of the Mustang IA

**F-6A** - Recon version of the P-51. The F-6A could carry an oblique camera behind the pilot, and the ability to carry a vertical camera suspected, but not confirmed.

**A-36A** - The A-36 was the dive-bomber version of the Mustang, with 4 x 0.5" cal. wing guns, 2 x 0.5" cal. 'cheek' guns, pylons under the wings, and dive flaps on top and below the wings. The A-36 had the fat intake, which contains an air filter, and the inlet to the radiator is now fixed (*i.e., no variable opening*). The A-36 also was equipped with a newer, wider chord Curtiss Electric propeller.

**P-51A** - This was the fighter version of the A-36. Cheek guns and dive flaps deleted. The pylons were repositioned and plumbed for drop tanks. A new Allison V-1710 with more horsepower was fitted, along with the new wider chord Curtiss Electric propeller.

**Mustang II** - RAF version of the P-51A. The Mk.II was able to carry the oblique camera behind the pilot, and was often fitted with vertical and additional oblique cameras.

**F-6B** - American recon version of the P-51A that had provisions to carry a vertical camera between the radiator exhaust and the tail wheel.

## THE A-M KIT

The Accurate Miniatures (A-M) Allison Mustang kits set new standards when they were released in the early 1990s. Moulded in either a medium grey or dark olive drab plastic, the panel lines are finely executed; moulding is generally crisp, and the fit is excellent to very good. These kits come in A-M's false bottom box (*plastic above, and the decals, instructions and clear parts below*). The original instructions are pretty pathetic, so try to get the newer versions of the instructions ([accurate-miniatures.com](http://accurate-miniatures.com)). You can download some of the later instructions from their website. Still not the best (there are several errors in the new instructions, so beware) they are a vast improvement over the originals. Decal options tend to be ho-hum, and you get two options at the most. The decals themselves are very usable. **A-M have released the Mustang IA, P-51, P-51A, A-36A, F-6A and F-6B** to date. The clear parts are commendably clear, but only one style of camera port 'quarter glass' is provided (*the oval type*), and only if the kit has the oblique camera option. The F-6 kits do not come with the provisions for the vertical camera.



As in all kits, the A-M Mustangs have some problems (If you ever find the perfect kit, I want to know about it!). Most are relatively minor, but annoying:

◆ First is the **propeller**. It looks like someone stuck a scale 2 x 8 wood plank on the hub and called it the prop. It needs replacing. There were **two different props used by the Allison Mustang**. The first, used on Mustang I, IA, P-51, and F-6A production, was a **narrow chord Curtiss Electric** three bladed prop. The second prop, used by the P-51A, Mustang II, A-36 and F-6B, was a **wider chord three bladed Curtiss Electric** prop. The easy way to



**A Mustang Ia/P-51 during assembly. Please note the rear of the wheel wells are not like the "wall" of the Accurate Miniature kit, or any other Mustang kit, the main spar is the back "wall" of the well. Smithsonian Institution Image**

tell the difference is that the earlier prop tips tend to be more pointed. The later prop has rounder tips.

◆ The next item is the **lack of seat armour**. Although NA did not fit the armour in early deliveries of the Mustang I, they soon developed the armour, and supplied kits to add it to existing a/c. The RAF also developed seat armour and had it manufactured locally

◆ Only **one style of camera window** opening is supplied for the oblique camera. I have counted at least five, and the camera window provided is only for the port side. There were bulged, egg shapes, round, Perspex, or metal and could be found on either side. For the F-6A and B, the provisions for the vertical camera is located between the radiator and the tail wheel, and its access hatch is not provided.

◆ Finally, one error found in this kit and all Mustang kits which is difficult to fix are the main wheel wells. The rear wall in the kit did not exist on the real airplane. Rather the main wing spar formed the rear of the well, and it ran straight from wingtip to wingtip. So the kit's rear well wall needs to be removed, and stiffeners added to be 100% accurate. I don't do it as it does require a bit of work. **Photo 1** shows the rear of the wheel well

wheel for the Allison Mustang. Fixes for the shortcomings which are contained within the A-M kit (with the exception of the wheel wells) are fairly common, and easy to do:

- ◆ the many **cockpit interior sets have the seat armour**
- ◆ **Ultracast makes a late prop and a Mustang I conversion, seats, exhausts, and other bits**
- ◆ **Falcon and Squadron have vacuum-formed canopies.**
- ◆ others bits such as **new 20 mm cannons can be acquired from the Hasegawa Typhoon and Hurricane kits.**
- ◆ **The earlier pointed and later paddle bladed Curtiss prop is found in the Eduard P-39/P-400 kits.**

So all is not lost, and detail parts can be had easily.

The kit used for this article is the Mustang IA; part number 3410 was released by the 'original' A-M (**Photo 2**). It comes in medium grey plastic and includes the oblique camera and window. Decals are included for two Mustang IAs, but A-M does not explain to which squadrons these aircraft belong.

The **Ultracast Mustang I conversion set** (No. 48031) (**Image 3**) will be used. The set includes a new prop (not used, as it is the later wide chord prop), a cowl gun insert, cowl gun barrels, and wing inserts. I also added the **Ultracast flared exhausts (No. 48070)**, **Ultracast Early P-51 Production Seat (No. 48014)**, **Eduard prop blades**, and **Arrow Graphics** and **Aeromaster** decals.

## CONSTRUCTION STEPS

I found the best way to build these kits is to simply follow the instructions, and so that is what we will do for this exercise.

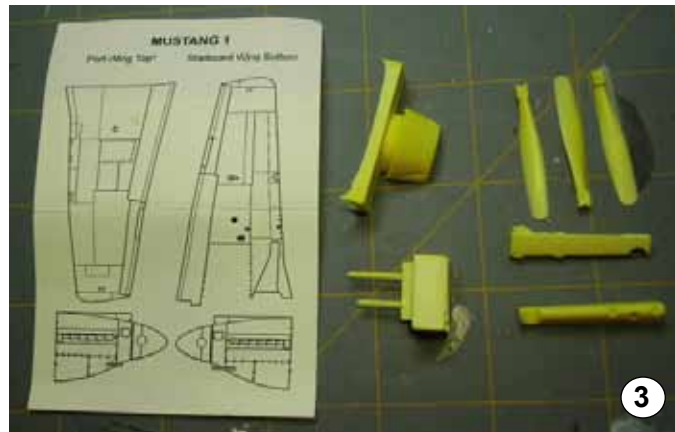

**The Ultracast conversion set includes a new prop, cowl insert, wing inserts, and the "cheek" guns.**



Now, I cannot stress this enough, you have to download the newer instructions for this kit. The old ones have several mistakes, and they are poorly illustrated. The following steps are based on the newer instructions, for the F-6A, No. 480017. These can be downloaded from the AM web site ([www.accurate-miniatures.com](http://www.accurate-miniatures.com)).

**Step 1:** Step 1 is fairly straightforward, with the following exceptions. First is the **basic colour of the interior** is actually **Dull Dark Green (DDG)** (approximately FS 595a **34092**) and **not** Interior Green. Just substitute the Dull Dark Green for Interior Green. The side console details are black and bits of Olive drab. I changed the kit seat for an **Ultracast part (No. 48014)** because I had one. However, with the addition of belts, the kit seat can be used (**Image 4**).

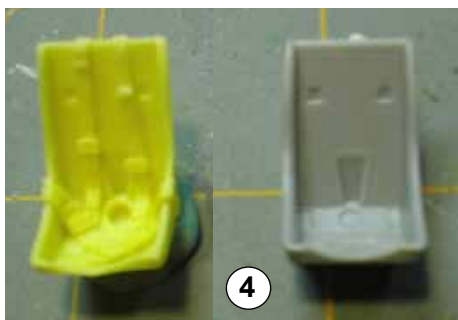

The Ultracast seat, on the left was used as I had one. The kit seat is usable if belts are added. The seat used had the "Q" harness and should have been the Sutton harness.

There are several ways to do the instrument panel. The first is to use masking fluid to mask the dials, and then paint the panel black. Add the decal behind, remove the masks and you have a nice panel. Or paint the panel black and punch the decal instruments out and apply them. Or just go the dry brush route. It is up to you... I chose the dry-brush route, as I do not have a micro punch set. Part 20, the seat frame can also be in Aluminum, or Yellow Zinc Chromate.

**Step 2a:** We continue with the interior. More careful painting is called for in this step. Part 30, the radios, are not mentioned in the instructions, but are clearly shown. The floor is DDG, and the radio receivers are semi-gloss black. They have silver detail. It is up to the modeller if they wish to add the prominent wires to the radios. Part 31 gets cemented to part 1, right fuselage. The radio transmitter mount is next. The radio transmitters have semi

gloss black sides and tops, and dull silver details. As noted earlier, Hills' aircraft was not fitted with the oblique camera. Where the radio transmitters mount is DDG. Again it is up to the modeller to add (or not) the prominent wires. But be warned, the wiring cannot be seen once the fuselage is assembled. Wiring is white, buff or black. The cockpit floor is DDG, with the fuel gauges on the floor in gloss black, the control lock at the front of the stick is red, the stick can be in DDG (most common) or olive drab with a gloss black grip. Attaching brackets have been seen in Aluminum, DDG and Yellow Zinc Chromate. Make sure parts 31, (receivers) 82 transmitters and mount, and 14 (cockpit floor) are perpendicular to the fuselage half. The interior of part 32 (radiator exhaust) and the interior of the airframe around part 32 is Yellow Zinc Chromate.

**Step 2b:** Here is where we make a part omitted by AM. It is the seat back armour. The seat armour measures in 1/48 scale thusly: the lower part is 10 mm wide and 18 mm tall, the upper section of the armour is 7 mm wide at the base and 3 mm wide at the top, with a height of 6 mm. 1 mm of the upper section overlaps the lower section when assembled. The overall height of the assembled armour is 23 mm. Make it out of thin sheet plastic (plastic card). Or use the armour from one of the many cockpit sets, such as Verlinden or True Details (**Image 5**).

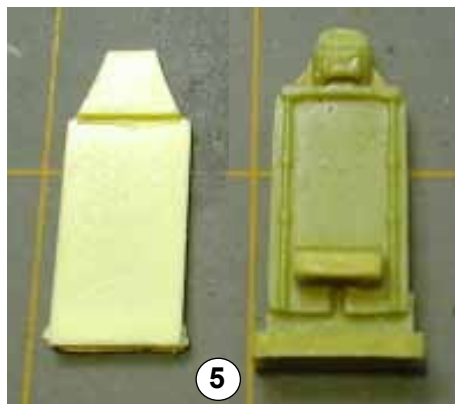

Commercially available seat armour is shown. The True Details armour is shown on the left, and the Verlinden is on the right. Either is usable, or the armour can be made from plastic sheet.

This armour was in either **Olive Drab** or **DDG**. The armour gets cemented between the seat frame and the rollover frame. Parts 13 (roll over frame) and 2 (left fuselage half) are in DDG. Part 16 is DDG with black details. Parts 33 (listed as 22 on

the left fuselage half) are the landing gear handle and the bomb release lever. Leave the bomb release lever off. The tail wheel and the well were painted Aluminum. **CAREFULLY** align the various mounts and glue the fuselages together.

**Step 3:** Big parts now. Paint the front of the radiator housing from Step 2b flat black. The instructions are correct in this step, remembering the horizontal tail is perpendicular to the vertical tail.

**Step 4:** Here is where we need to correct an error in the kit. The kit prop is horrible. It is much too thick, and is shaped wrong for a Mustang I, IA, P-51 F-6A and A-36A. The Ultracast propeller is for the later P-51A, F-6B, A-36 and Mustang II. I do not know if anyone else makes a resin replacement. But hope is not lost. For those who have purchased the Eduard P-39/400, there is a treasure trove of spare parts in the kits. The best are the extra propellers. It includes early and late Curtiss Electric and Aero Products blades. Eduard part number B-6 blades are early, narrow chord blades as fitted to the P-39/400 and Mustang I (and F-6A, Mustang IA, P-51) (**Image 6**). To use them, cut off the kit blades at the hub. Using the kit blades, trim the Eduard blades to the same length, making sure you trim from the root end. Drill a hole in both the new blade and hub, and using a pin, glue the new blade to the hub, making sure the blades are separated by 120 degrees, and all have the proper pitch. This one step improves the look of the kit immensely. Blades are semi-gloss black with yellow tips. They may or may not have had the Curtiss Propeller decals applied. Finish as per the instructions, but the lower cowl has

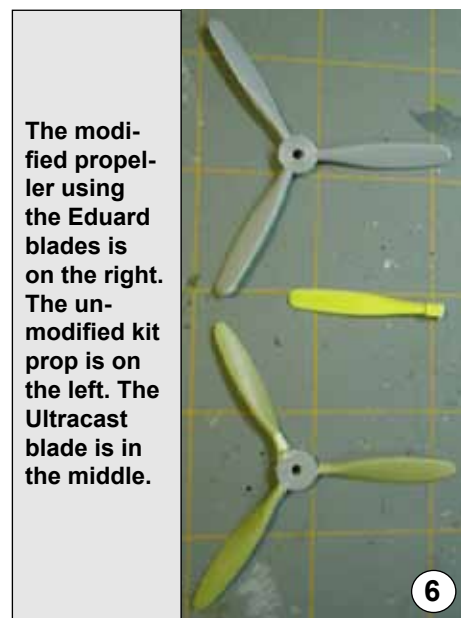

The modified propeller using the Eduard blades is on the right. The unmodified kit prop is on the left. The Ultracast blade is in the middle.



**7**  
This view shows the wheel doors in the “up” position and the modified shell ejection ports.



**8**  
The wing insert on the port wing. The amount of filler is an indication of the not-so-precise cuts made.

to be trimmed to allow the Ultracast cowl gun insert to be added. **Remember to measure twice and cut once.**

**Step 5:** Here is where the **most common building error** in Allison Mustangs occurs. With Allison Mustangs, **the hydraulic system was different than the system used in Merlin Mustangs.** The wheel doors (parts 28R and 28L) remained in the ‘up’ or closed position at all times, unless the gear was cycling. The instructions hint that this is the way it should be, but do not tell you this IS the way it actually occurred. So the wheel wells, gear doors, and struts, should be aluminum paint. The wheels being left in natural magnesium or aluminum. Replacement gear struts were often seen in Neutral Grey. **Delete parts 35 and 42.** Trim the wheel doors to fit in the up position, and glue them that way (Photo 7). **Omit the drop tanks as the Mustang I could not carry them.** When the wing is assembled, trim the leading edge as per the Ultracast instructions and add the inserts (Photo 8). **The better at cutting you are, the better these will fit** (trust me, I know!). Using

the Ultracast instructions, modify the shell ejection ports on the underside of the wing (Photo 8). Remember to remove the three identification lights from under the starboard wing.

**Step 6:** Assemble the remainder of the kit as per the instructions. The Ultracast exhausts were used (Photo 9). If you use the Malcolm hood, delete the antenna and install a whip antenna from your favourite medium. It must be noted here that most Mustang Is (all of the images I have seen) did not use the Malcolm Hood.

These were seen mainly on Mustang IA, Mustang II, and F-6B in the European Theatre. Hills’ Mustang I did not have the Malcolm Hood. If you do decide to use the Malcolm Hood on a future project remember to add the tracks the hood slides on. The IFF antenna was a dipole under the starboard wing.

The ‘cheese cutter’ IFF antenna was not fitted. Also, the RAF had changed to UHF radios, and did away with the antenna wire. The actual antenna ran up inside the antenna mast. But (there

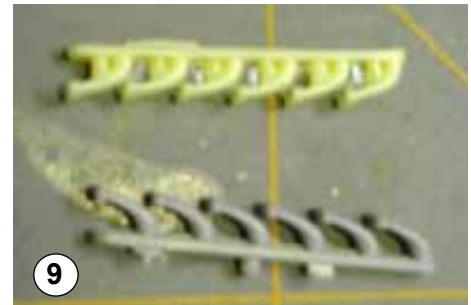

**9**  
The Ultracast exhausts (top) were used. The kit exhausts are on the bottom.

is always that pesky “but”!) there are images of Mustang Is with the antenna wire. So check those references! I deleted the antenna wire. **Image 10** gives a view of the completed cockpit. The clear parts, although very clear, were dipped in Future.

### CAMERA or NOT?

The kit did not pose any problems during assembly. However I had added the camera. After the aircraft was gloss coated for the decals, I found out that **AG470 did not have an oblique camera fitted.** I did manage to remove the camera and mount without doing any damage.

After the removal of the camera and mount the model was promptly dropped and needed multiple repairs. I did keep breaking off the pin for the prop to mount on. During the build, which started in April, I moved from New Jersey to Florida, and had two computer meltdowns.

Aeromaster RAF national insignia were used as I had them, and they looked

better to me. I also noticed some filler shrinkage (measure three times, then cut once!) from where the Ultracast bits were added. The filler used was Squadron White Stuff. In the future I will be using 3M Acryl-Blue Spot putty as I find it shrinks less than other solvent based fillers.

When I went to paint the kit, I found my compressor had been damaged in the move, and the box containing my airbrush was missing. Fate had taken an unkind interest in this build, and I did

**10**  
The completed cockpit. Note the colour, Dull Dark Green.



not want to antagonize fate any further so the entire kit was brush painted, including the flat coat.

## MUSTANG COLOURS

Allison Mustangs were delivered in one of two different schemes, which depended on who was to receive the airframe. Mustang Is were delivered to the RAF in Brown, Dark Green, and a Grey which appears to be close to the FAA/RAF colour 'Sky Grey'. Mustang IA and II were delivered in the same scheme. P-51s and F-6As which were initially taken from the British order were finished as above. P-51s built to a USAAF order, as well as A-36A, P-51A and F-6Bs were finished in **Dark Olive Drab 41** and **Neutral Grey**. The Olive Drab when fresh was dark, similar to Humbrol's old Dark Olive Drab or Tamiya Olive Drab in the jar. In theatre, the RAF soon refinished the Mustang into its current scheme (**Ocean or Mixed Grey, Dark Green and Medium Sea Grey**). **IPMS Stockholm has a good article on Mustang Colours** and variants on their website ([www.ipmsstockholm.org](http://www.ipmsstockholm.org)). Use their search engine to find the article.

**Mixed Grey** was introduced due to a shortage of **Ocean Grey**, was made by **mixing seven (7) parts Medium Sea Grey and one (1) part Night**. The aircraft had the Sky fuselage tail band, prop spinner, and squadron codes. It also had the yellow wing identification bands (Both the leading edge ID bands, which run from the wingtip to the outer gun and the chord-wise bands).

## PAINTING & MARKINGS

Polly Scale colours were used, and the mixed grey was mixed the same way as the RAF did, seven (7) parts Polly Scale Medium Sea Grey and one part Polly Scale NATO Black (Night). The Polly Scale colour Sky was muted (it is too green) by adding Medium Sea Grey to it. Future was used to gloss the kit prior to the application of the decals and post decal application. The decals used were **Arrow Graphics No.D-35-48** for Hollis Hills Mustang I at Dieppe (**Photo 11**).



The Arrow Graphics decals had a rough finish to them, so I decided to use only what I needed to from the sheet(s). Too late I realized the serial went over the Sky band, and the rough surface caused major silvering. A fix using Future was attempted (*flood the silvered area with Future, and poke holes in the decal so the Future can*

Originally seen in **RT 32/3**

*seep in eliminating the silvering*). Also the chord-wise ID bands were translucent, and a second decal sourced from the Accurate A-36A kit was needed to cover the Arrow Graphics decal. But due to the rough texture of the Arrow Graphics Decals, the new stripe did not sit correctly and looks blotchy. If I were to do this again, I would put a white decal down first, then a yellow stripe. The second alternate would be to paint the stripes. But time constraints and pure frustration caused me to leave well enough alone. Otherwise the Arrow Graphics decals reacted well with the

Micro Decal System, both to Micro Set and Sol. The roundels came from Aeromaster sheet No. 48-106, "Early Mustangs". The leading edge ID stripes are from the kit. **Polly Scale Flat finish** was used as a topcoat, all hand brushed. Images 14 and 15 show the completed kit.

RU<sup>○</sup>M was flown by Pilot Officer Hollis Hills, an American from California in **No 414 Sqn, (RCAF)**, on August 19,

1942 and while over Dieppe, shot down a Fw 190 and damaged a second, the first air to air victory of many for the Mustang. Hollis Hills later joined the US Navy, and scored four more 'kills' while flying F6F 3 Hellcats in the Pacific.

## SUMMARY

There you have it, a more accurate Allison Mustang. The information presented here is the latest and best I could locate. But aviation research is fluid, and new facts are uncovered every day, which make the subject so exciting. The majority of these items are applicable to all of the Allison Mustangs. The Accurate Miniatures Allison P-51s are fairly easy builds, and I would recommend them to everyone. The Ultracast parts fit well and were beautifully cast. The gaps were caused by over zealous cutting, and not the parts. The Aeromaster decals worked as well as they always seem to do. But the Arrow Graphics decals had that rough surface which caused all sorts of problems. This was the first time I have used Arrow Graphics decals, and unless this set was a fluke (oddy) I will probably not use them in the future. Now to find one of those ICM P-51As...Just remember: build what you want, how you want.



**Allison Mustang Characteristics Comparison**

	Mk.I	Mk.Ia	P-51	F-6A	A-36A	P-51A	Mk.II
Engine*	V-1710-39	V-1710-39	V-1710-39	V-1710-39	V-1710-87	V-1710-81	V-1710-81
Carb Intake	Thin	Thin	Thin	Thin	Fat	Fat	Fat
Prop Blades**	Thin	Thin	Thin	Thin	Wide	Wide	Wide
Cheek Guns	2 X 0.50"	None	None	None	2 x 0.50"	None	None
Wing Guns***	2 x 0.50" 4 x 0.303"	4 x 20 mm	4 x 20 mm	4 x 20 mm	4 x 0.50"	4 x 0.50"	4 x 0.50"
Wing Pylons	No	No	No	No	Yes	Yes	Yes
Dive Brakes	No	No	No	No	Yes	No	No
Oblique Camera	Yes	Yes	Yes	Yes	Yes	Yes	Yes
Vertical Camera	Possibly	Possibly	No	Possibly	No	No	Yes
Adj. Radiator Intake	Yes	Yes	Yes	Yes	No	No	No
Malcolm Hood	No	Possibly	No	No	No	No	Yes
Wing ID Lights	No	No	Yes	Yes	Yes	Yes	No

\*=The engine is a General Motors Built Allison V-1710

\*\*=The prop is a three bladed Curtiss Electric unit

\*\*\*=The guns are listed as per wing

**REFERENCES**

- ◆ Camouflage and Markings, "RAF Fighter Command Northern Europe 1939 to 1945, North American Mustang" Doubleday and Co., 1971
- ◆ In Detail and Scale, "P-51 Mustang Part 1", Squadron-Signal Publications, 1996
- ◆ Wings of Fame, Vol.1 "North American P-51 Mustang" Aerospace Publishing, 1995
- ◆ American Fighters of World War II, "North American P-51 Mustang" Doubleday and Co., 1969
- ◆ 2nd Tactical Air Force, Vols. 1 through 3, Classic Publishing (Ian Allen Publishers), 2004 to 2006
- ◆ Walk Around No.13, "Allison Powered Mustangs", Squadron-Signal Publications, 1998
- ◆ Camouflage and Markings No.16, "North American P-51 and F-6 Mustang USAAF, ETO and MTO 1942-1945", Ducimus Books, No Date
- ◆ Planes and Pilots, "P-51 Mustang From 1940 to 1980", Histoire & Collections, 2003
- ◆ Famous Fighters of the Second World War, "North American Mustang" Hanover House, 1957
- ◆ On Target Profiles No.2 "RAF and Commonwealth P-51 Mustangs", Aviation Workshop Publications, No date.
- ◆ Scale Aircraft Modeling, Vol. 17 No.8 (October, 1995) Aircraft in Detail "P-51 Mustang in RAF and Commonwealth Service", Guideline Publications
- ◆ Model Aircraft Monthly, Vol.4 No.4, "Mustangles", SAM Publications
- ◆ Air Classics, Vol. And No. Unknown (article removed from magazine) "The Allison Mustangs" Parts 2 and 3, Challenge Publications
- ◆ Modeling Madness, Various Mustang articles by Tom Cleaver ([www.modeling-madness.com](http://www.modeling-madness.com))
- ◆ IPMS Stockholm, "Camouflage and Markings of North American P-51 Mustang, Parts 1 through 4", ([www.ipmsstockholm.org/magazine/1999/12/stuff\\_eng\\_profile\\_mustang1.htm](http://www.ipmsstockholm.org/magazine/1999/12/stuff_eng_profile_mustang1.htm))
- ◆ IPMS Stockholm, "Modeller's Guide to Early P-51 Mustang Variants", ([www.ipmsstockholm.org/magazine/1999/11/stuff\\_eng\\_p51early.htm](http://www.ipmsstockholm.org/magazine/1999/11/stuff_eng_p51early.htm))
- ◆ Cybermodeler, "RAF Allison-Powered Mustangs" (<http://www.cybermodeler.com/special/mustang.shtml>)
- ◆ E-Mail Conversations With Colin Ford on RAF modifications and camera fits on RAF Mustangs
- ◆ E-Mail conversations with Tom Cleaver about his interview with Edgar Schmued
- ◆ E-Mail conversations with Terry McGrady about RAF Allison Mustangs, and Mustang Repainting

**ACKNOWLEDGEMENTS**

I would like to acknowledge the following people for their help, and for just putting up with me:

◆ My wife **Dana**, who encourages my hobby for the benefit of the boys and myself.

◆ **Joe Lyons**, who plays devil's advocate and keeps me honest.

◆ **Tom Smith**, a fellow lover of Allison Mustangs.

◆ **Tom Cleaver**, for not only interviewing Edgar Schmued, but generously sharing his notes.

◆ **Colin Ford**, for his vast knowledge of RAF Allison Mustangs.

◆ **Terry McGrady**, for his input.

◆ and your ever-suffering Editor **Steve Sauvé**, for the patience during my family move to Florida and several computer failures.

I thank you all!



**Editor's Note: My sincere apologies to the entire membership of IPMS Canada for missing several key elements of Bruce's Mustang article in RT 32/3. This PDF version is roughly what it should have looked like in the journal.**

**- Steve**

**About the author:**

Bruce Archer is a Geologist by trade; he recently moved from New Jersey to Central Florida (though he would have preferred Calgary). Fortunately, the daily sounds of radial engines and Merlins overhead from a nearby air museum have eased the transition. Bruce has been modelling for longer than he likes to remember. His major interests are Spitfires, Allison Mustangs, Zippers (F-104s), Harriers and the FAA. He has written several articles on modelling and aviation history and he also dabbles in N-Scale model railroading. Bruce has been married to his lovely wife Dana for seven years and they have 5-year-old triplet boys (who have started building).

Another modeller's idea of how to build a 1/48 Allison-Powered Mustang, flown by P/O Hollis Hills, 414 Sqn, RCAF, Dieppe, 1942...



by Gary Barling, C#0014,  
IPMS Ottawa  
Photos by the author except as noted

## 1/48 RCAF Mustang Mk. I - Part 2 -

### BACKGROUND

RT 24/3 (Available as a back issue - Ed.) featured a superb article by Toronto member Cam Harris on modifying/retrograding the Accurate Miniatures 1/48 Mustang IA to an RCAF Mk. I. Something about the aircraft and the model attracted me, and I can well-remember thinking, "Now, THAT would be a super model to build!" At least, that's what I thought before getting into the details of the article. When I read what Cam had actually done to achieve the modification, I realized that the project was a tad beyond my somewhat limited capabilities. I'm an "out of the box, add a few bits and pieces, not too bad a finish"-type modeller.

Somewhat later I was browsing the Ultracast website, and I found reference to a resin set (#48031) that allowed the conversion of the Accurate Miniatures Mustang IA to an RCAF Mustang I. I broke two fingers and sprained a wrist clicking to that particular page, and lo and behold: there it was! Ultracast offers a

Members: To download a free PDF of the original Mustang I articles listed in the references, visit [www.ipmscanada.com](http://www.ipmscanada.com)

modification set that included two leading edge inserts (featuring the three guns to each side and the landing light housing), one chin insert, two machine gun barrels for the chin part (one longer than the other, as it should be), and four propeller blades. I sprained the other wrist clicking on the order form and, in about four days, the set arrived in a three-ply cardboard box that would deflect a bullet. On examination, all of the parts were beautiful: smooth, no bubbles, easy to separate from their carrier stubs, the gun barrels were hollowed out and the cooling jackets beautifully represented. Happiness is!!

I will not go into many details of the standard model build, as Cam Harris covered that aspect very well. All to say that the kit is extremely good: excellent fit, finely scribed panels, well engineered... need I say more? I did have a bit of trouble fitting the pilot's seat, but I had opted for an Ultracast seat vice the kit offering, and had to fiddle a bit to get it positioned correctly. That being said, any problems I had with the Ultracast parts were because of me and my inexperience with resin aftermarket, and not because of

anything to do with Ultracast. Plasticard formed the armour plating behind the seat. The kit I had was an early edition that I bought on eBay, and I found that the canopy was a little pitted in spots. Micromesh, elbow grease and Future solved that little problem. I replaced the antenna with a length of brass tubing, producing a more-to-scale appearance. The antenna wire was simply magic-

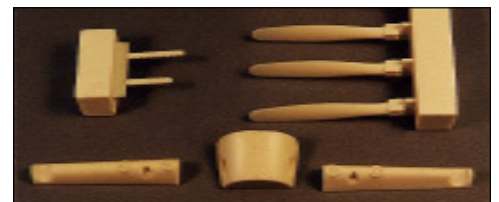

(Both photos courtesy Ultracast)



marked fine fly-tying line, attached at both ends with super glue.

## ULTRACAST CONVERSION

To use the mod set, the theory is simplicity itself. You just cut along the existing panel lines to remove the 20 mm cannon leading edges of the kit wings, and then slip the new inserts into place.

it but to drop the flaps. However, I found this out after I had glued the wing together, so I went through a real spell of carefully cutting, grinding, filing and sanding to get the kit flaps off, then more filing and sanding of the internal wing surfaces to fit the flaps stolen from a Tamiya P-51D (which will themselves be replaced with Ultracast flaps, but that is another story). The work was worth it.

spar therein. I used the Arrow Graphics sheet for F/O Hollis Hills, 414 Sqn RCAF at Dieppe, and referred to RT 24/1 for the camouflage pattern and markings for this aircraft. The decals went down with a little difficulty, probably because I have had them for so long. The kit then received a sealing coat of Future polish, thinned with a few drops of Windex. This cuts surface tension and provides a smoother finish.



Same thing for the chin insert. I had noticeable problems with the leading edge inserts, again due to me and not the parts. I ignored one of the fundamental rules: "Measure twice, cut once!" Or, as Brett Green of HyperScale says, "Always remember the Golden Rule of Cutting - cut less than you think you need, then trim!" I should have cut well inside the scribed panel lines, then slowly trimmed, sanded and fitted until the insert slid into place. Not me! I cut right along the panel line, cut too far, and had to delve into my plasticard and putty supply to fill the gaps. And I've only been building since 1955 (sigh)... The chin insert went much better (amazing what you learn by experience), and only a smidge of filler was needed there. I was a bit concerned about the alignment of the chin guns: would they line up, or would I need to tweak them into place? No worries: they slipped into place without a murmur, and lined up as if they'd been bore sighted.

A friend advised me that, when Mustangs were at rest, the hydraulics bled off and the flaps dropped. So nothing for

The propeller blades are ingeniously designed. They are as thin as a whisper, and are fitted with a small block at each internal end. The blocks have a small hemispherical cutout in them, which allows you to fit them over the kit propeller shaft. Ultracast has even engraved a small "F" on each block to ensure that that side faces to the 'Front'. And you will recall that I said that you get four blades. You need only three for the Mustang I, but Ultracast knew that I might break one, so they provide an extra blade. That is service! I used two other Ultracast sets: the exhaust set and the smooth wheels (as were used by the early Mustangs). Both added noticeably to the model's appearance

## FINISHING TIME

I find that I get best results from Xtracolor paint, so their line provided the Ocean Grey, Dark Green and Medium Sea Grey for the camouflage, Trainer Yellow for the identification bands and leading edges, Aluminum/Aluminium for the main wheel wells, and the Zinc Chromate for the main

Next came a coat of Dullcote, decanted into a bottle with a touch of grey added, then thinned slightly with lacquer thinner and airbrushed over the model.

## WEATHERING

I weathered/accented the model using 0.5 mm pencil lead. Scribbling until I formed a fine chisel edge to the lead, I drew it along the panel lines. As the lead dulled, I rescribbled another chisel edge and continued. Then, using an old cut down paintbrush, I 'scrubbed' the panel lines gently, bringing the lead up onto the surface and darkening it slightly. I find that I can control the effect better than doing an airbrushed shading exercise. Plus, if I make a mistake (who? Me?! I can just erase the line and redraw it. Finally, another Dullcote application dulls the polished lead and blended it all in.

## SUMMARY

All in all, I had a great time building this model, errors in parts fitting

notwithstanding. Now that Accurate Miniatures has re-released the Mustang IA, supply of this excellent kit is no longer a problem. The Ultracast set greatly simplifies the modification for mere mortals like myself, and I highly recommend it.

### REFERENCES

- ◆ Ultracast Modification Kit - [www.ultracast.ca/products/48/031/default.htm](http://www.ultracast.ca/products/48/031/default.htm)
- ◆ Cam Harris, North American Mustang

I, RT 24/3 (visit the IPMS Canada website to order a copy)

- ◆ Bill Coffman, The First Mustang, RT 24/1
- ◆ Camouflage and Markings, North American Mustang, RAF Northern Europe, 1936-45, Ducimus Books
- ◆ Review - [www.kitreview.com/reviews/ultrabg\\_6.htm](http://www.kitreview.com/reviews/ultrabg_6.htm)



### About the author:

Gary Barling was born and raised in the Toronto area and subsequently served 40 years in the Canadian Army. He's 65 and has been retired since 2004. Modelling since 1955, His main area of interest is aircraft, with strong minors in

armour and ships. Gary's been a member of IPMS Canada since 1965 and currently the Chapter & Member Liaison Rep on the IPMS Canada National Executive. He maintains dual citizenship in both IPMS Ottawa and IPMS Farnborough in England.



# The First Mustang

by **Bill Coffman**; Drawings by **Ralph Clint**

In 1940, the RAF needed additional fighters for longer range photo reconnaissance and army cooperation. They approached North American Aircraft to license produce Curtiss P-40s, who felt they could design and produce a better aircraft, and a contract was issued in April 1940 for 320 aircraft. The first flight of the NA-73X took place only 120 days later. The new machine was powered by the Allison V-1710 and featured a laminar wing and coolant radiators mounted below the fuselage behind the wing.

The first production NA-73 Mustang (RAF serial AG345) was flown on April 23, 1941. It was armed with two 0.50 machine guns flanking the engine and one 0.50 and two 0.30 machine guns in each wing. A total of 620 Mustang Is were delivered by July 1942.

In mid-1942, the Mustang was issued to eleven RAF squadrons and three RCAF squadrons (400, 414 and 430). It was initially used for attacking and photographing German installations in France on 'Rhubarb', 'Popular' and 'Circus' operations.

During the Dieppe raid on August 19, 1942, the Mustang achieved its first air-to-air victory when H.H.Hills, an American serving with 414 Sqn in Mustang I AG470 shot down an FW-190. Ten Mus-

tangs were lost to enemy aircraft and ground fire that day.

By the end of 1943, Allison Mustangs were in service in all theatres of the war. The Canadian squadrons in Europe assumed a tactical role, as well as acting as low level bomber escorts. On D-Day, 414 and 430 squadrons were still operating Mustang Is, 400 squadron having switched to Spitfires. By late 1944, all had transitioned to Spitfire Mk IX, Mk XIV or Mosquitos. Over sixty Allison engined Mustangs were in RAF service at the end of the war, but it was the Merlin engined Mustang that got all the glory.

## Modelling the Mustang I

The only 1/72 kit of an Allison Mustang to date, including vacs and resins, had been the old Frog/Novo Mustang II. The fuselage profile was too thin; the lower engine cowl's curve was too flat; the ventral radiator scoop shape was too thin and lacked detail and the whole kit suffered from raised pane lines and deep sink marks. The general wing shape appeared OK.

The old Monogram 1/72 P-51B offered possibilities for conversion to a Mustang I but the lower cowling shape had to be revised and the carb intake added. The ventral rad also had to be reshaped. The

wings were correct for the early Mustangs, but a three blade prop was needed from the scrap bin. The Airfix P-51B had to be converted in the same manner, plus it has incorrect wing roots where the 'gloves' over the landing gear more closely resemble those of a P-51D. The Hasegawa P-51B has P-51D wings, shallow wheel wells and an abbreviated vertical tail.

The Aviation USK resin kit is the latest and best offering in 1/72 scale; its overall configuration matches drawings perfectly. The one piece wings are right on, with deep wheel wells and a correct leading edge. The fuselage walls are injection thin and the resin parts include the cockpit sidewall details, hinged radiator vent, seat and seat mounting, wheels, props, control panel and landing gear bits, plus the air brakes for the A-36 dive bomber.

Despite the excellence of the kit, this is not a Mustang I. The first Mustangs had a thinner ventral radiator with a hinged scoop under the front and a similarly hinged scoop to the rear. The top of the rad intake sloped upward to each side of the centreline parallel to the wing dihedral with square top corners and flat sides. The P-51A, A-36 and Mustang II had a definite notch in the top edge of the inlet to clear a rib on the

Cont'd on p.28

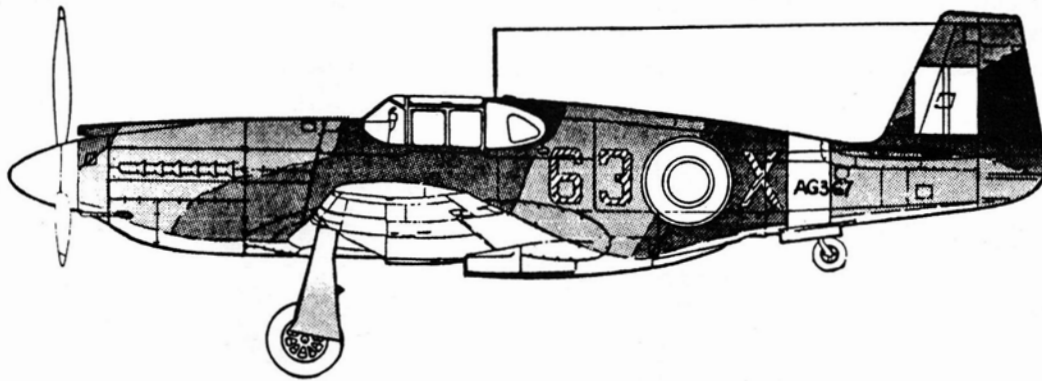

400 Sqn. RCAF  
1942-43  
• Sky spinner & fuselage band  
• 30" yellow codes  
• Yellow L.E. stripe  
• No wing bands

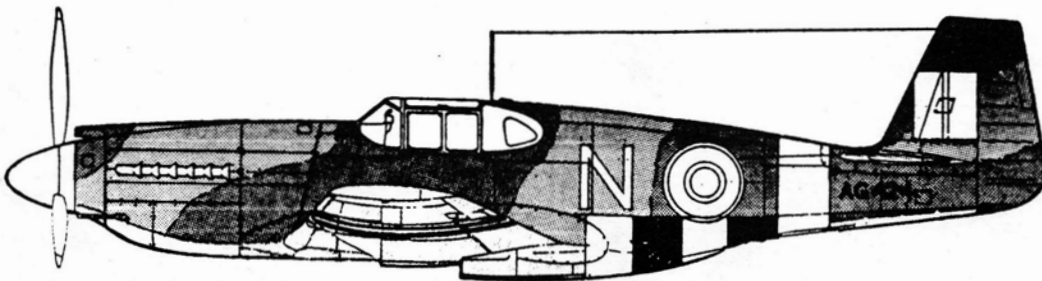

430 Sqn. RCAF  
June to September 1944  
• 18" wide black & white invasion stripes, underside only  
• Sky spinner, fuselage band  
• 30" code  
• yellow L.E. stripe



PROPELLER IS A CURTISS ELECTRIC & SERVO-OPERATED UNIT WITH STEEL BLADES OF 10' 6" DIA. AS USED ON A/C AG 346, 348-367, 369-377. OR ALUMINUM BLADES OF 10' 9" DIA. AS USED ON A/C AG 346, 347, 368, 378-664.

ENGINE: ALLISON V-170-39  
 T/O RATING 1150 BHP @ 3000 RPM  
 NORMAL 1000 BHP @ 2600 RPM @ 10800'  
 MILITARY 1150 BHP @ 3000 RPM @ 12000'  
 EMERGENCY 1470 BHP @ 3000 RPM @ 3 L.  
 MAX SPEED 390 MPH @ 8000'  
 SERVICE CEILING 32000'  
 CLIMB 8.1 MIN. TO 15000'  
 RANGE 1050 MILES  
 LANDING SPEED 90 MPH

gun camera location on early aircraft  
 on later models, located on centre-line between nose guns

SPAN 37' 0 5/8"  
 LENGTH 32' 2 7/8"  
 HEIGHT 12' 8" one blade vertical  
 TRACK 11' 10"  
 WING AREA 233 sq ft  
 WING CHORD 8' 8" at a/c E, 4' 2" at ws 215  
 INCIDENCE +1° at a/c E, 0° at ws 215  
 DHEDRAL 5° at 25% thickness  
 L/E SWEEP 3° 35' 30"  
 THE 25% CHORD LINE IS AT FS 89  
 STABILIZER SPAN 13' 2 1/8"  
 INCIDENCE +2°  
 DHEDRAL 0°  
 FIN OFFSET 1° PORT

NA-73 MUSTANG I AG 346 - AG 664  
 NA-83 MUSTANG I AL 958 - AM 237  
 AP 164 - AP 263  
 NA-91 MUSTANG IA FD 418 - FD 587  
 NA-99 MUSTANG II FR 890 - FR 938

ARMAMENT: MUSTANG I, 2 50 CAL. IN FUSELAGE NOSE,  
 2 50 CAL. IN WINGS (INBOARD)  
 4 30 CAL. IN WINGS (OUTBOARD  
 AND CENTRE POSITION)  
 MUSTANG IA 4 20 MM CANNON IN WINGS  
 MUSTANG II, 4 50 CAL. IN WINGS

AG470, RU-M OF 414 SQN. RCAF, WAS FLOWN BY F/O HOLLIS H. "HOLLY" HILLS, RCAF, DURING "OPERATION JUBILEE", THE DIEPPE RAID, 19 AUGUST 1942. ON HIS SECOND FLIGHT OF THE DAY, HE SHOT DOWN A FOCKE-WULF FW-190A, HIS FIRST VICTORY, AND THE FIRST ENEMY AIRCRAFT TO FALL TO A MUSTANG

400 AND 414 SQNS. WERE THE ONLY RCAF UNITS OPERATING MUSTANGS AT THAT TIME, AND WERE JOINED BY 430 SQN. IN JANUARY 1943. THESE SQUADRONS FLEW THE MUSTANG I ONLY.

Mustangs of this period were camouflaged in DARK GREEN and OCEAN GREY (or MIXED GREY, 7 parts MEDIUM SEA GREY, 1 part NIGHT) on upper surfaces, and MEDIUM SEA GREY on lower surfaces. The spinner and fuselage band was in SKY, as were the code letters. The leading-edge stripe and chord-wise band were YELLOW. Serial number was in NIGHT. Some aircraft had the chord-wise band in RED.

Remaining area of left-rear quarter-light usually painted in adjacent camouflage colour.

right main under-carriage, inside face and rear view.

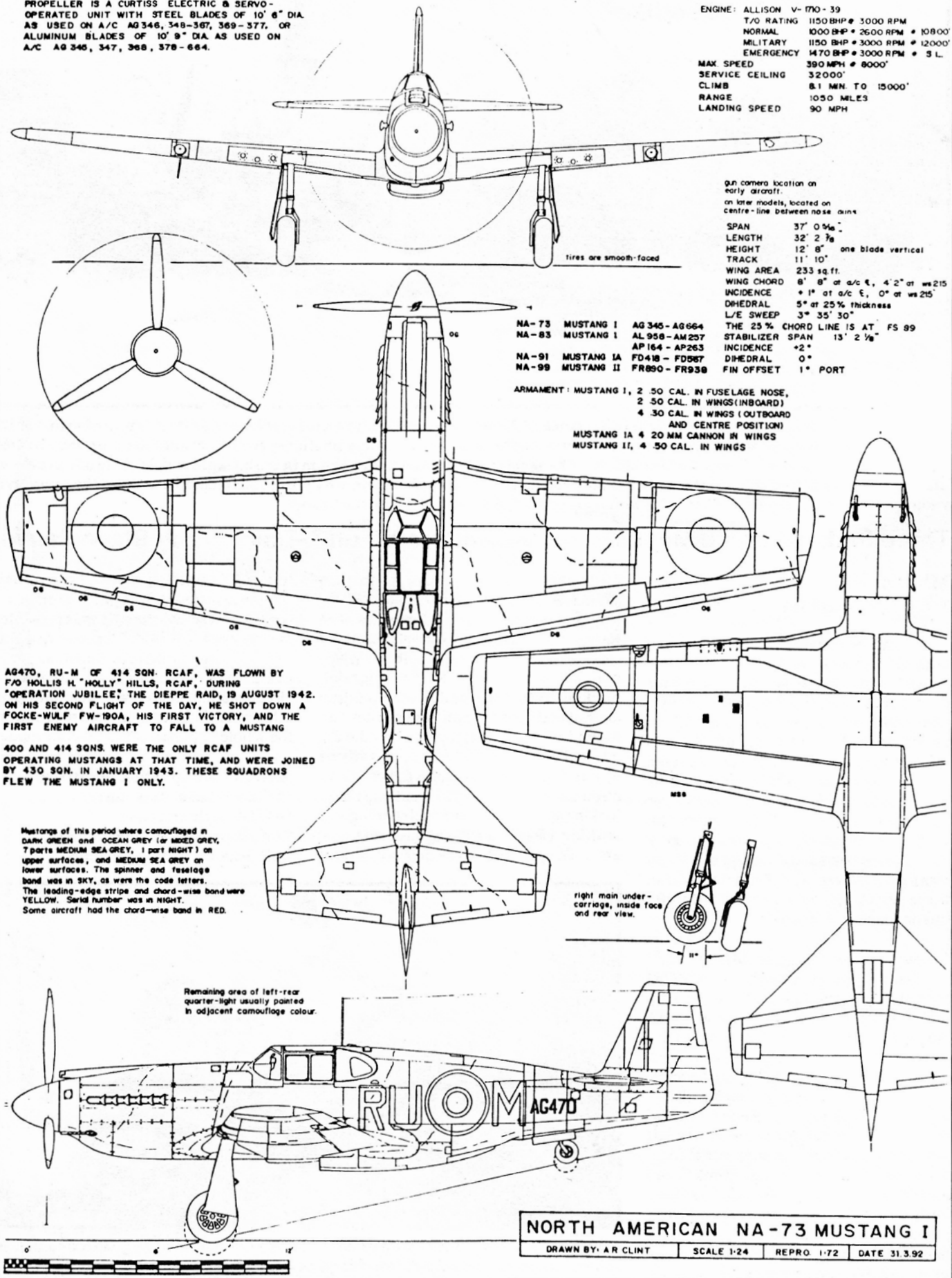

**NORTH AMERICAN NA-73 MUSTANG I**  
 DRAWN BY: A R CLINT    SCALE 1:24    REPRO: 1-72    DATE 31.3.92

**Mustang cont'd from p.10**

wing centreline as well as rounder sides.

To convert the USK kit to a British Mustang I as flown by the RCAF on the Dieppe raid, thin down and straighten the top of the rad scoop. Add the 0.30 gun ports in the wing, relocate the landing lights and fill in the dive brakes.

1/48 scale modellers are luckier. With three fine new Allison Mustangs from Accurate miniatures, its relatively easy to build an RCAF Mustang I. The only inaccuracy is in the shape of the rad intake as viewed from below. The sides should be relatively straight, instead of tucking in to the front and the intake lip should be widened by about 2mm. The movable front scoop should have parallel sides. There is no panel line surrounding the intake. For a Mustang I, the inlet should be configured as described above. The wings will also have to be modified to have the ports for the three guns in each wing and the two 0.50s will have to be added to the cowling. finally, the carb intake on top of the cowl should have straight sides. Don't forget to add the spade grip to the control column.

Mustang Is were camouflaged in a standard British day fighter scheme of Dark Green and Ocean Grey on upper surfaces over Sea Grey Medium. The fuselage bands, spinner and codes were usually in Sky. Roundels after May 1942 were 36" Type C2 on the fuselage, 40" Type B on the upper wings and 32" Type C under the wings. The fin flash was 24" x 27" Type C. The wings had a yellow identification band on the leading edge from the tips to the guns, wrapping 3" back on each surface.

Most D-Day Mustangs had invasion stripes on the underside only, since they were used on low level attacks. In addition, by 1944 these aircraft appear pretty dirty and battered, so the weathering fanatics can have a field day.

This article appear with the kind permission of the author, Bill Coffman, and is reprinted from the CME 94 souvenir book. (well worth picking up if you find a copy).

---

**Want Ads**

Clive Reddin needs RT 18-2 and 20-2 to replace missing copies. He will reimburse for postage. Please call or write before sending. His address is 27 Goodall Drive, Scarborough, Ontario, M1B 5C8. Phone is (416) 287-8558.

Robert Lepine wants an Airfix Space 1999 Eagle (approx. 1/100 scale). He would prefer one in mint condition, but will accept any condition, even parts of one! Write him care of Hobby Wonderland, 6290 Quinpool Road, Halifax, NS, B3L 1A5.



A well-known photo of F/Lt Burroughs' Mustang. The photo was taken at Ashford, Kent, on 13 September 1943, about half-way through its life. It first flew operationally with 414 (FR) Sqn on 23 November 1942, and was lost in action on 18 June 1944. (Canadian Forces / RCAF Photo PL 19833, via Steve Sauvé)

### **Mustang I, AM251/O, 414 Squadron, 'The Samia Imperials', RCAF**

AM251 joined 414 (Fighter Reconnaissance) Squadron in September 1942 and operated continuously with this unit during its 21 month life as an RCAF Mustang. This is noteworthy, as the average life of an operational Mustang was around the 12 month mark.

Flight Lieutenant (F/Lt) George W. Burroughs, DFC, joined 414 Sqn in March 1942 and took his first of 173 flights in AM251 on 19 September '42 (if talking to his bomber friends he would say that "AM251 brought me back on one engine 173 times"). Although flown by other pilots in the squadron, AM251 was his airplane, or as he called it, his 'little jewel'. He liked this particular Mustang simply because it was a good airplane with smooth handling characteristics.

In June 1944 F/Lt Burroughs flew AM251 on 9 of its 20 missions. In that period he produced a couple of milestones for 414 Sqn which are noted in the following summary of AM251's operations for the month:

**Note 1** - On the squadron's first mission of 06 June, F/Lt Burroughs took off at 0500 hrs on a gun-directing mission for HMS Ajax. A German concrete-fortified coastal artillery position was the target and F/Lt Burroughs guided the ship's fire to silence the battery. On these missions, the pilot would stay around 1000', so that the shells would (hopefully) pass over him on their

way to the target. Mr. Burroughs said that you could actually see the shells in flight, and they were always given the right-of-way.

**Note 2** - On his second mission of 06 June, F/Lt Burroughs took off around 0730 and, since the primary target had been destroyed, he flew inland to look for something else to give the ship's attention to. A German flak battery, in what was surely their worst decision of the day, started shooting at AM251. F/Lt Burroughs brought Ajax' guns to bear on the battery, bringing an abrupt end to their part of D-Day.

**Note 3** - On his mission of 07 June, F/Lt Burroughs shared a Ju 52 kill with Flying Officer (F/O) R.A. Bromley. This was noted in the Squadron diary as 414's first kill on the second front (after D-Day). Mr. Burroughs said that this encounter was simply a matter of luck (good or bad, depending on which aircraft you were flying). He and F/O Bromley were exiting their target area at low level and high speed when the Ju 52 appeared in front of them. After a little manoeuvring they each gave it a burst as they flew past, and it went down to crash in an open field.

**Note 4** - On his second mission of 12 June (t/o at 1530 hrs), AM251 developed engine trouble and forced F/Lt Burroughs to land (at 1640 hrs) at St. Croix sur Mer, a forward Allied airfield in France, becoming the first 414 Sqn pilot to do so. Unfor-

tunately, there was no one there who could repair an Allison engine. F/Lt Burroughs and the rough-running AM251 started at the end of the PSP runway, revved up to the maximum power available and took off, returning to England that evening (t/o 1745 hrs, landed 1840 hrs).

**Note 5** - On the last mission of 18 June '44, AM251 and AM220 (with F/Lt Mackelvie) were sent on a Tactical Reconnaissance of the Le Beney Bocage area. AM251 was flown by F/O Roger A. Bromley, F/Lt Burroughs' friend and wingman on the mission of 07 June. F/O Bromley flew fairly often as #2 with F/Lt Burroughs. F/O Bromley's aircraft was down for maintenance and he borrowed AM251 from F/Lt Burroughs because he knew it was a good airplane. Mr Burroughs revealed that the Mustangs engaged enemy aircraft and a dogfight ensued. Although outnumbered, F/O Bromley and F/Lt Mackelvie downed three German fighters before being shot down themselves. This was the final flight of AM251.

### **Flight Lieutenant George R. Burroughs, DFC (RCAF retired)**

In researching this article I had the great pleasure of meeting several times with George Burroughs at the local RCAF Association bar. He is a modest, soft-spoken man, and was amenable to sharing his time with me to help prepare this article. Mr. Burroughs finished the war with a total of two kills: 1/2 of an Ar 96, an Me 109 (both on 28 January '44), and

1/2 of a Ju 52 (07 June '44). The '109 kill occurred when he was joining up with another section of two Mustangs. He sighted the enemy aircraft, manoeuvred to a firing position, and nailed it from straight behind. He was going so fast that he passed the Messerschmitt on its starboard side and later thought about how he could have taken some closeup photos of it with his oblique 5" camera. I asked why his victories were not marked on AM251, and Mr. Burroughs simply replied that "it wasn't really worth it - it's not like I got a dozen or something like that". This is indicative of a man who didn't get too worked up over his own accomplishments.

Mr Burroughs pointed out to me that the primary role of a Fighter-Reconnaissance unit was to obtain and return with information requested by other combat units. These requests could be of either tactical or strategic importance, with bridges, rail yards, radar sites, results of bombing missions, etc., being on the typical target list. In fulfilling their primary role, enemy aircraft were occasionally encountered and fights did take place, but it was not their job to clear the Luftwaffe from the skies. Bringing back good target pictures or observations was far more important than shooting down aircraft.

The reference photo and several drawings of AM251 have been widely reproduced over the years, making it probably the best-known RCAF Mustang of the war. Mr. Burroughs was a bit surprised by this, asking "are there really people interested in this sort of thing?" I realized that this is probably a typical reaction from a wartime fighter pilot; they were just over there doing their jobs, and the airplanes were just the machines in which they did them. They didn't particularly care about the paint and markings - they were interested in getting in and out alive.

On 21 July '44, 414 Sqn received a Spitfire V for familiarization prior to converting to the Mk.IX. F/Lt Burroughs took this aircraft, AR452, up for some local flying on 22 July, and noted in his logbook - "Sold on type - a lovely little aircraft". F/Lt Burroughs' last operational flight was on 25 July '44. He flew AM147 on a Tactical Recce of the Amiens area, marking his 125th mission. He was then posted back to Canada on instructional duties, and was discharged from the RCAF at the end of the war. 414 Sqn received its first five Spitfire F.R.IXc's on 03 August '44. They moved from Odiham to B21 (Ste. Honorine-de-Ducy, France) on 15 August '44, and re-commenced operations on 16 August '44.

### Colours and Markings for AM251

It is obvious from the September 1943 reference photo that AM251's paint job was nowhere near factory fresh. Two other photos of AM251, at Harrowbeer in May 43, and at Gatwick in February '44, show what is essentially the same paint job on the aircraft. Mr. Burroughs said that the ground crews maintained the paint by touch-ups, but an entire aircraft was not repainted at a unit.

### British or US Colours? Coin-Flip Time!

AM251 was painted in one of two colour schemes. If it still had its original American paint it was Olive Drab 613 and Sea Grey 603 over Light Grey 602 (see Note 1). If it was repainted in the UK, it could have been Olive Drab or Dark Green, and Ocean Grey or Mixed Grey, over Medium Sea Grey (see Note 2). See the table at Note 3 for a comparison of the US and British colours. In either case, it had soft-edged camouflage, with around 1" or so of overspray. The aircraft had the standard Sky code letter, fuselage band, and spinner, and it also carried the Yellow wing leading edge strips. There were no wing chord bands on AM251 (these were ordered removed in December '42 - there are faint signs detectable of possible paint-over in the reference photo).

**Note 1** - These colours are the American ANA (Army-Navy Aeronautical) equivalent colours, authorized for application in place of the actual RAF colours for Mustangs. According to Reference 2, p.48, ANA 603 Sea Grey was substantially darker than RAF Ocean Grey, and was more closely matched by RAF Extra Dark Sea Grey, and was/should have been eventually repainted with Ocean Grey or Mixed Grey.

**Note 2** - Reference 2 indicates that this a/c was painted in both of the authorized upper surface Grey colours, which is certainly possible. The same reference noted that Mustangs were arriving in the UK as late as May '42 with the Dark Green/Dark

Earth/Sky colour scheme, and from then with ANA 603 Sea Grey replacing the ANA 617 Dark Earth (unfortunately, I don't have the delivery date of AM251 from the USA). Because of paint shortages, Mixed Grey was an expedient colour authorized for use when fighter aircraft were ordered, in August 1941, to use Ocean Grey in place of Dark Earth for upper surface camouflage. This colour was comprised of seven parts Medium Sea Grey to one part Night (Black) paint. It is noted to have varied considerably in tone, and was/should have been replaced by Ocean Grey as supplies became available. In examining the September '43 photo of AM251, one can see that the Grey on the wings and rear fuselage appears slightly lighter than the nose section of the airplane (D1). This may be where Reference 2 got the idea that the aircraft was painted in both grey colours at the same time. This photo was taken a year after AM251 entered service with 414 Sqn, and probably has not been repainted, leading to this weathered appearance.

**Note 3** - The colour matches in the table below have been drawn from the References listed in the table below. If you don't have access to an FS595 fan deck, book, or 3" x 5" colour cards, this information may not be of much use to you. Suffice to say that, according to the references, the American ANA substitute colours listed below are quite different from the genuine RAF colours:

### Rudder

Although different in tone from the rest of the aircraft, it was painted green (D2). My guess is that it is a replacement rudder, probably painted in fresh US Olive Drab 41, or maybe RAF Dark Green. Mr. Burroughs isn't sure if it was a replacement, but he is sure that he didn't damage it! In any event, it has no camouflage pattern and is a bit darker than the other Dark Green areas on the aircraft.

Colour/ANA Code	Ref. 2	Ref. 12
RAF Dark Green	34087*	34079**
Olive Drab 41/ANA 613	34087	34087
RAF Ocean Grey	-	36152
Sea Grey ANA 603	36118	36118
Neutral Grey 43	-	36173
RAF Medium Sea Grey	-	36270
Light Grey ANA 602	36440	36440

\* Noted to be 'virtually an exact match' by Ref 12.  
 \*\* Ref.12 also lists 34064 and 34096 as alternate matches

### Cowling / Fuselage Colour Anomalies

As seen in the September '43 photo, the aircraft, from the windscreen forward, has a large area of darker Dark Green (D3). It is not a continuous patch of colour; part of a dark grey pattern shows up on the cowling just above the 'mustang' marking (D4). The engine cowling camouflage pattern matches the pattern for the rest of the airplane, but has varied from AM251's original paint job (see photo). The dark green area just aft of the engine panels is a very slightly different shade of green (D5); it follows the angled panel line and ends at the wing root fillet, instead of carrying onto the wing itself (mis-matches of components' camouflage patterns were apparently very common on Mustangs. Reference 2 indicates that the wings and fuselages were painted in different shops, and compromised paint patterns were frequent.). The two dark grey areas visible at the cockpit and nose (D6) seem to be a little darker than the dark grey on the rest of the fuselage and wings. Also note the port cowl gun panel is a slightly lighter shade of dark grey (D7).

Speculation: AM251 was at least 12 months old when the September '43 photo was taken; the photographic evidence shows that the aircraft had been partly

repainted, or had had these parts replaced. Were these components in proper RAF colours? If the engine cowling is RAF-painted, this might explain why the camouflage on the rest of the aircraft, in faded American Olive Drab and Sea Grey or Mixed Grey?, looks lighter. Perhaps another engine and/or cowling was installed at some point in AM251's life, from an aircraft that had a similar, but different, paint pattern. It is also possible that the fuselage, from the cockpit forward, had been repainted in proper RAF Dark Green and Ocean Grey, because of wear and tear.

### Invasion Stripes

We don't have a photo of AM251 with stripes. Reference 2 indicates that Army Cooperation Mustang I's and IA's carried AAEF stripes on the lower surfaces only, to preserve the camouflage of these low-flying recce aircraft. However, Mr Burroughs recalls that his squadron's airplanes had full wrap-around invasion stripes. To support this, there is at least one photo which shows a variety of Allied aircraft parked at an RCAF forward airfield, including a Mustang I with full wrap-around AAEF stripes! Post-D-Day photos of 414 Sqn Mustangs show stripes only on

the lower surfaces, but Mr. Burroughs is certain that their aircraft received the full stripe treatment. Perhaps the upper stripes were applied to Mustangs after some aircraft recognition errors? In this regard Mr. Burroughs said that he would have preferred advertising the fact he was one of the good guys rather than risk being mistaken for a Luftwaffe aircraft. As is the case with most D-Day aircraft, the stripes would have been hastily applied for the early days of the invasion, so don't be too neat about applying these markings on a model. Should you not be comfortable with modelling a Mustang with wrap around invasion stripes, the lower-only stripes were painted up to the long horizontal panel line, which is easily identifiable on the kits.

### RCAF 'Roundel'

AM251 wore the official RCAF marking decal, which consisted of a thin dark blue outer ring, light blue disc, and a red maple leaf (D8). During the August '94 conversation with Mr. George Burroughs (Reference 1), he produced a photo which, among other things, showed a closeup of this roundel marking on AM251. This revealed that it did indeed have this marking as described above.

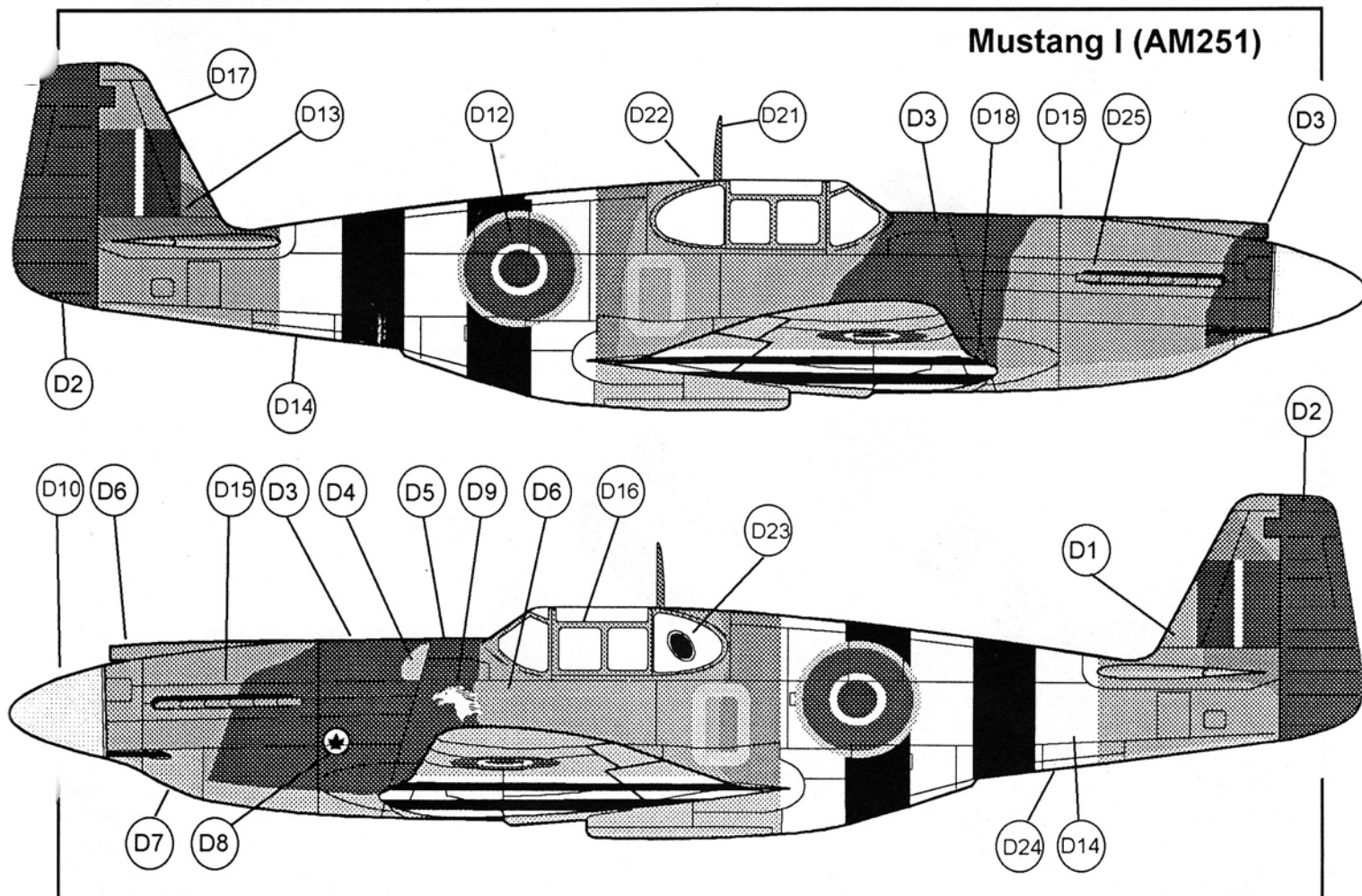

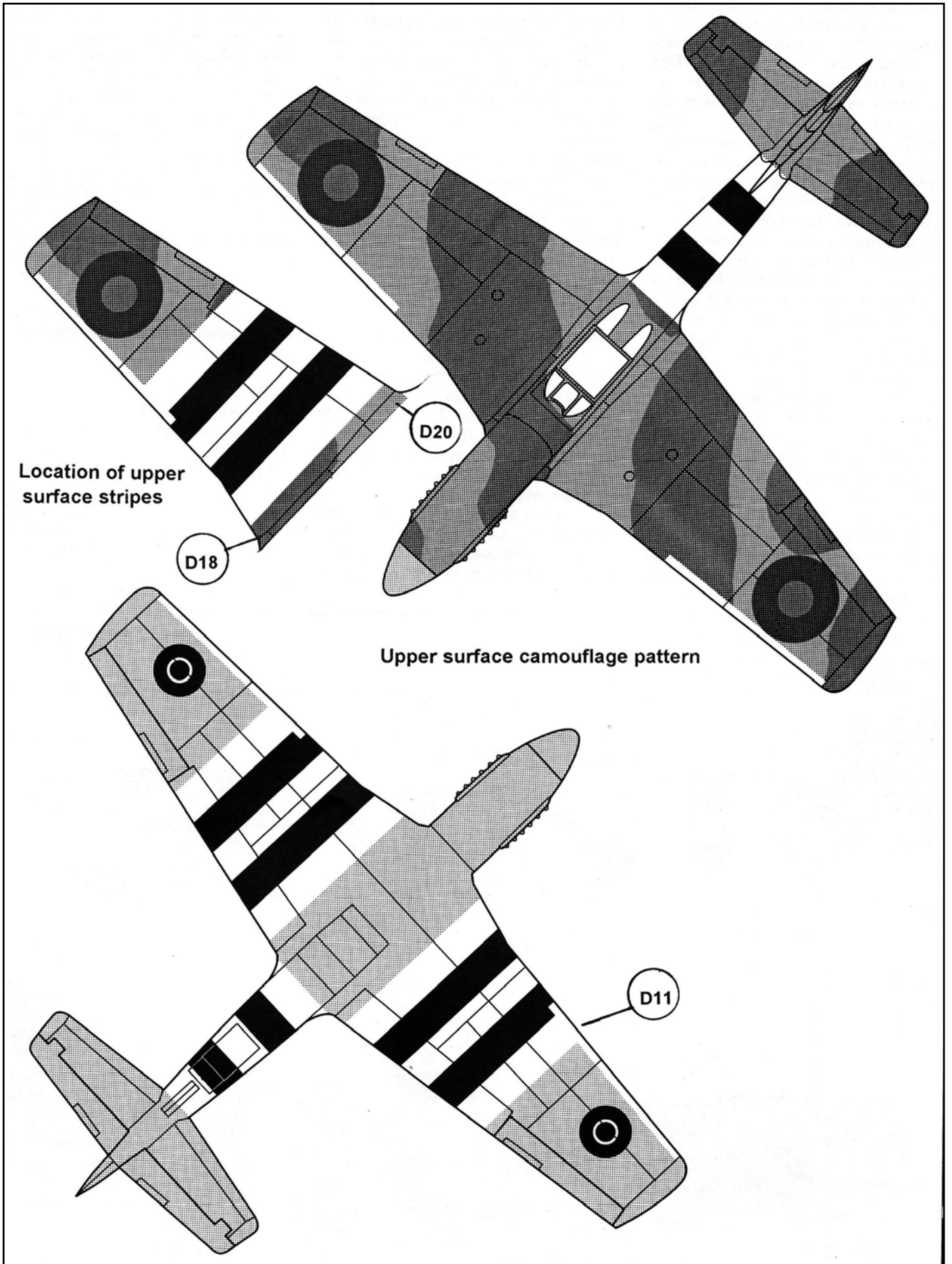

### Mustang Head

Mr. Burroughs indicated that this was painted in white with black details, only on the left side of his airplane (D9). This was done by Eric Aldwinkle, who was a war artist on the strength of 414 Sqn at the time. Mr. Burroughs chose the mustang simply because it was something appropriate to go with the airplane's name (Reference 1).

### Pistol Packin' Momma

A photo taken in February '44 at Gatwick shows the mustang head marking, the RCAF marking decal, and a personal inscription, Pistol Packin' Momma. Mr. Burroughs said that this marking was on the airplane for a short time only, and he believes that it had been removed before D-Day.

### Aircraft Configuration Notes (derived from photos of AM251):

(D10) the propeller did not have yellow tips on its rear face (facing the pilot). This is not unique to AM251 - other Mustangs have been noted with the same anomaly. (D11) there seems to be a small antenna mounted on the lower wing, visible between the port undercarriage and wing flap. Its function is unknown.

(D12) there are two small rear-facing louvred fittings visible on the fuselage roundel. It is a common, if not standard, feature on the Mustang I, but its position is not fixed to one location on the airplane. Two are most commonly found at the top of the fuselage, directly between the aft cockpit windows; AM251 had these louvres in the other position on the fuselage, visible at the front edge of the C1 fuselage roundel. Good photos of these two positions are on p.21 and p.37 of Reference 6. The panel is approx. 6" x 6", with rounded corners. Part of the fitting is a small flange around the edge; four rivets in the corners of the flange hold it on the aircraft. I suspect that these louvres have something to do with de-misting the camera bays, and/or cooling the electronic equipment housed behind the pilot.

(D13) the bottom of the tail flash shape follows the lower fin panel/fillet line; this marking is not square along its bottom edge.

(D14) visible below the serial AM251 are two lines of letters - CIG-C and then 83A (the Mustang I type number).

### Miscellaneous Notes

(D15) there is chipped paint along the cowl fastener points and panel lines.

(D16) the frames on the port fold-down cockpit side window are also chipped.

(D17) there is paint chipped from the fin leading edge and also on the panel below



AM251 in Harrowbeer, Devon in May 1943. The aircraft at this stage still has its original rudder, and the cowling colours appear to be the same as the rest of the aircraft. (George Burroughs photo)

the fin flash.

(D18) there is paint chipping along the wing root fillet.

(D19) there is some oil and crud streaking on the cowling and fuselage.

(D20) there is 'popped' paint on wing fillet rivet heads.

(D21) there is no HF antenna visible in the photo, only the mast.

(D22) directly aft of the HF mast is a small fitting whose function is unknown. It appears to be a standard item for Mustang Is fitted with cameras. My guess is that it is some sort of flight metering device for the film exposure system, but I am willing to be educated here. An excellent photo of

this can be seen on p.25 of Reference 6.

(D23) the hole in port rear window, for oblique photography, is reinforced along the edges. Examination of contemporary photos shows there is no set pattern for these camera openings. Many different styles can be seen at one squadron at the same time.

(D24) the Sky tail band does not appear to wrap around the tail gear doors. The tail gear doors could be all Sky or, more likely, Medium Sea Grey/Light Grey 602.

(D25) AM251 had flared exhaust stacks (supplied in the Accurate Miniatures P-51 and Mustang IA kits).

F/Lt George Burroughs in AM251 at Gatwick in February 1944. In this photo can be seen the mustang marking, the RCAF marking decal, and a personal inscription, (Pistol Packin' Momma) that was removed before D-Day. (George Burroughs photo)



## Modelling the Mustang I

### General

Aside from the armament changes described below, the Mustang I was similar to its US counterpart, the P-51. Although the Mustang I is generally believed to have had a control column with a round RAF-style 'spade' grip, Mr. Burroughs is certain that their aircraft were fitted with the original, American style pistol-grip, a fact he had confirmed with other former RCAF Mustang pilots. There is other evidence supporting this, for example the photo on p.24 of Reference 6, where an American-style column is clearly visible in an RAF machine.

The Mustang I carried a mixed armament of 4 x 0.30" and 4 x 0.5" machine guns mounted in the wing and engine 'cheek' mounts, vice the 4 x 20 mm cannons in the P-51. They also carried an F.24, 5", reconnaissance camera mounted behind the cockpit for 'over-the-shoulder' oblique photography, or another F.24 camera, mounted aft of the belly scoop, for vertical photography. The two cameras weren't carried at the same time, and Mr. Burroughs indicated that the majority of the imagery obtained was shot oblique. When the belly camera was not used, a flat skin panel was mounted to cover that area.

### 1/72 Scale

There is the old Frog kit of the Mustang I, or you could try converting the Monogram P-51B to an Allison-engined aircraft. Either way, you're in for some work. In Reference 8, John R. Beaman, Jr. shat all over the Frog kit, and he suggested mating the Frog kit's engine to the rest of the Monogram kit as an alternative to the work required for the Frog kit. There is also the Aviation USK resin kit, but this kit also requires some work to turn it into a decent Mustang I.

### 1/48 Scale

The easiest route in the manly scale is the series of Allison Mustangs by Accurate Miniatures. They have produced the three American versions of the airplane, plus an RAF Mustang IA. None of these kits is a Mustang I straight from the box, but the Mustang IA is the closest because it comes with a fairly decent oblique camera installation. Note that the P-51 and Mustang IA kits, compared to the A-36 and P-51A kits, are the only ones with the correct belly scoop configuration for the Mustang I.

I settled on using the P-51 kit, opting to change the wing gun configuration and adding the 'cheek' 0.5" guns (note that the port barrel protrudes further forward than the starboard). If I decide not to do this, I can still use this kit as an RAF Mustang IA,

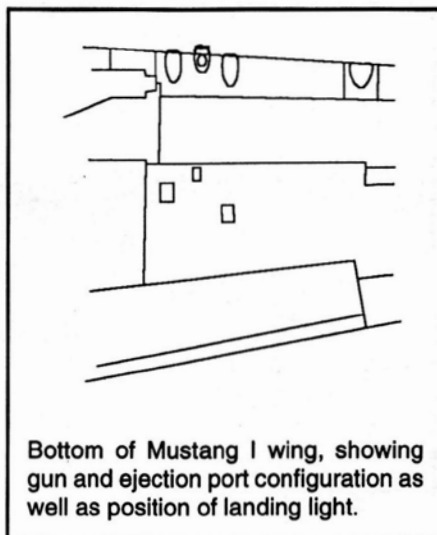

Bottom of Mustang I wing, showing gun and ejection port configuration as well as position of landing light.

which didn't all carry cameras.

In either event, the following parts of the kit need attention for conversion to a Mustang I:

- the tire tread on the main wheels was non-existent on most Mustang I's.
- the landing lights need to be moved outboard
- (optional) a floodlight on the port wing

Prior to the release of the Mustang IA, I obtained a Medallion Models conversion/update, #MM44, for the P-51 kit. This includes some of the parts needed to make a Mustang I, including the oblique camera, and you also get a new resin cockpit to replace what Accurate Miniatures has provided.

### Mustang I Fuselage

I have always felt (not in the womb, but right afterwards) that the Allison P-51s and the Merlin P-51B/C had different fuselage dimensions. The canopy on the Allison Mustang appears bigger, in relation to the amount of fuselage visible, than on the P-51B. In other words, I think the canopy is closer to the wing on Allison-powered Mustangs. In Reference 8 John Beaman stated that the fuselage aft of the firewall did not change between the Allison and Merlin variants, but there were panel line changes between the two airplanes that he couldn't explain. In Reference 7 A.R. Clint indicated that there was a 3" (76.2 mm) difference between the fuselage reference lines and the wing reference lines of the two variants. Chris Etzel of Medallion Models indicated that North American spent as much time re-engineering the Mustang fuselage to take the Merlin engine as they did designing the aircraft in the first place! Compared to the Monogram P-51B, the 1/48 Accurate Miniatures kit has this difference built in, and this is more like what I think the early Mustang looked like. Also, compare some

of the photos in Reference 4; page 23 shows the North American P-51B prototype. The modifications done to the front fuselage to fit the Merlin engine show the new cowling, extending well below the lower fuselage line, aft of the engine. Where did this go on the production aircraft? Were the Merlin engine's dimensions rearranged for the Mustang?

### References for Mustang AM251

1. August, November, and December 1994 conversations with George W. Burroughs/Steve Sauvé, Ottawa.
2. **Camouflage & Markings #2**, N.A. Mustang, Ducimus Books, 1971(?).
3. **P-51 Mustang in Color**, by Larry Davis, Squadron/Signal Publications, 1982.
4. **P-51 Mustang in Action (#45)**, by Larry Davis, Squadron/Signal Publications, 1981.
5. **P-51 Mustang, Classic Aircraft No.3**, by R. Cross & G. Scarborough, Patrick Stephens Ltd/Airfix, 1973.
6. **Mustang at War**, by Roger Freeman, Ian Allen Publications, 1974.
7. **First Blood for the Mustang**, by Ralph Clint, CAHS Journal, Spring 1992.
8. **The Unknown Mustangs**, by John R. Beaman, jr., 1975.
9. **RCAF Squadrons & Aircraft**, S. Kostenuk & J. Griffin, A.M. Hakkert Ltd, 1977.
10. Canadian Forces Photographic Unit, Ottawa. DND/RCAF photo PL 19833.
11. DND Directorate of History, Ottawa. 414 (FR) Squadron Operational Flying Records and War Diary.
12. **IPMS Color Cross-Reference Guide**, by David H. Klaus, 1988.

### Acknowledgements

I would like to extend my thanks to the following:

- the hard-working and soon to be understaffed people who work at DND's Director General History, for their help finding the squadron historical material.
- the National Aviation Museum for the generous access they granted to their Spitfire IXc, NH188.
- Mr. George Burroughs, who patiently fielded my many questions concerning him, his Mustang, and 414 (FR) Sqn, many of which pertained to details that only a modeller would have noticed (or cared about) during a shooting war.
- Cam Harris of IPMS Toronto. Cam really helped out by brainstorming some of the obscure features of the Mustang I.
- Bill Zuk of IPMS Winnipeg. Bill responded very quickly to my enquiries about Spitfire wing styles, and did some shooting and measuring of the WCAM Spitfire XVIe.





Cam Harris' excellent rendition of the Accurate Miniatures Mustang I, with a few (?) improvements along the way. This model won a ton of awards at the recent IPMS Ottawa Capcon, including Best Canadian subject, Best Aircraft and Best in Show.

## North American Mustang I

by Cam Harris

The North American Mustang Mk. I was the first version of the Mustang produced, and was a unique version of this famous fighter distinguished by its armament of four .30 calibre guns in the outboard wings and four .50 calibre guns in the inboard wings and nose. Overshadowed in history by the later Merlin-powered P-51s, the Mustang I was nonetheless a successful design, very popular with its RAF and RCAF pilots, and generally superior to its contemporary Spitfire V upon reaching operational status in July 1942. Its high speed at low altitude, coupled with long range made it a good performer in the ground-hugging tactical reconnaissance role. The heavy armament was good for the secondary role of tactical fighter, not to mention the ability to defend itself!

To create a Mustang I in the grander scale, 1/48, use either the Mustang IA or P-51 kit from Accurate Miniatures. The Mustang IA is better in that it already provides a fairly good representation of the camera behind the pilot. Otherwise, the conversion is the same, and is not difficult. Do not use the P-51A or the A-36

kits. Although these are also Allison engined Mustangs, they each have a broader carb intake and a much shallower radiator intake. All of the Accurate Miniatures Mustangs are beautiful kits with excellent fit, nice detail and fine scribed lines. The kits appear very well researched and are enjoyable to build. It is unfortunate that the photography of the assembled kit on the back of the kit box does not do the model justice.

### WING CONSTRUCTION

The wing is the most significant aspect of this conversion. Most noticeable is the change in wing armament from two 20mm cannon to two .30 cal. and one .50 cal. machine gun in each wing. (Fig. 1) Initially, I thought that I might be able to cut off the 20mm barrels, and use the stubs for the new gun fairings. However, the Mustang I's guns are further apart than the P-51's two 20mm's. After the upper and lower wing halves have been glued together, cut out a rectangular section of the wing leading edge, removing the 20mm guns entirely. Fill the cutout with a solid

block of styrene. This will be faired in a little later.

The location of the landing light in the leading edge is further outboard on the Mustang I, possibly to accommodate the ammo chutes for the different armament. Glue the kit landing light lens in place but don't worry about being too tidy since it will eventually be completely filled in and painted over as part of the conversion. To create a new landing light, it is easier and cleaner to cut out part of the leading edge and glue in an oversized solid block of clear styrene or acrylic. A solid rectangular block is much easier to fit than trying to match the contours of the finished light. The result is cleaner because only part of the block is masked off for painting, thus avoiding the refraction that otherwise results from seeing the edge of the clear part (as on airliner windows). A dimple drilled in the rear of the block prior to installation can be painted silver to represent the light reflector. The area inside the wing should be flat black, and you will want to be careful to ensure that the lens is not backlit by light coming in through any gaps in the

GH  
SEPT '95

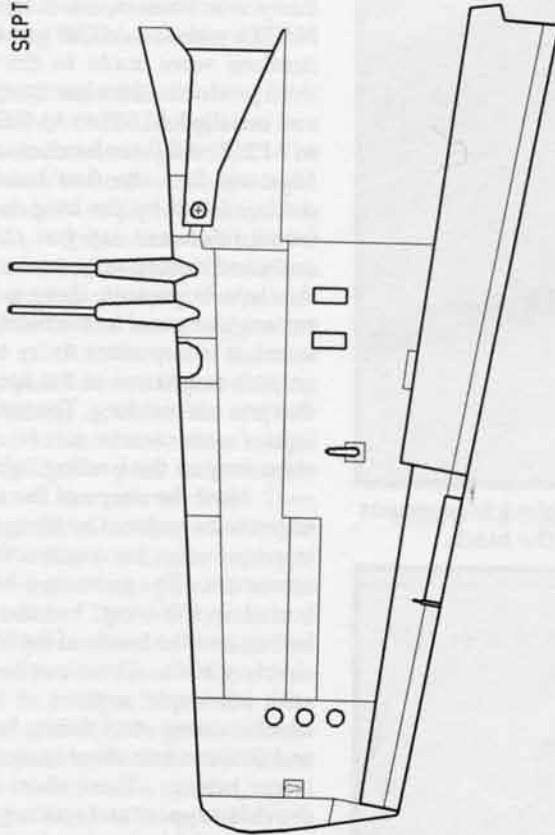

P-51 LOWER RIGHT WING  
1/48 SCALE

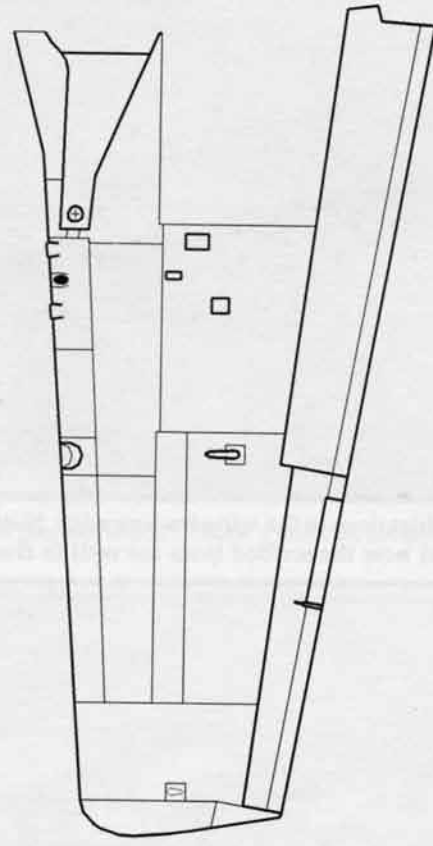

MUSTANG MK. I LOWER RIGHT WING  
1/48 SCALE

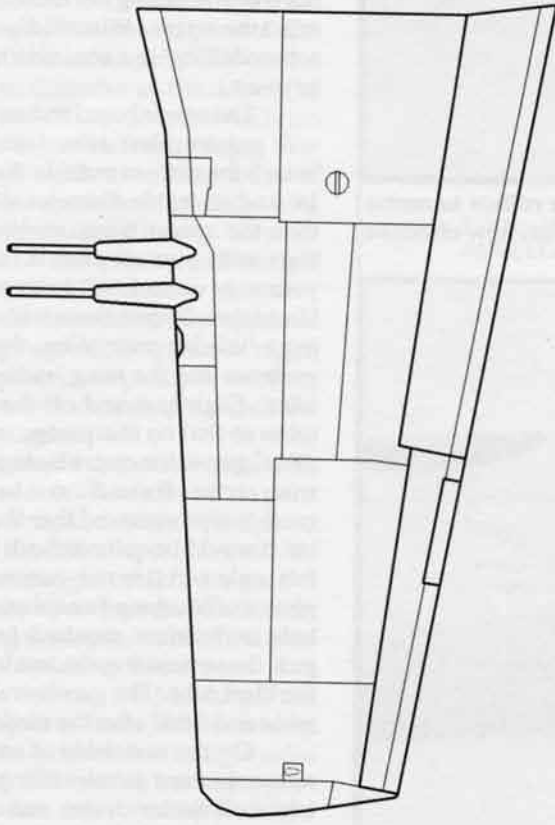

P-51 UPPER LEFT WING  
1/48 SCALE

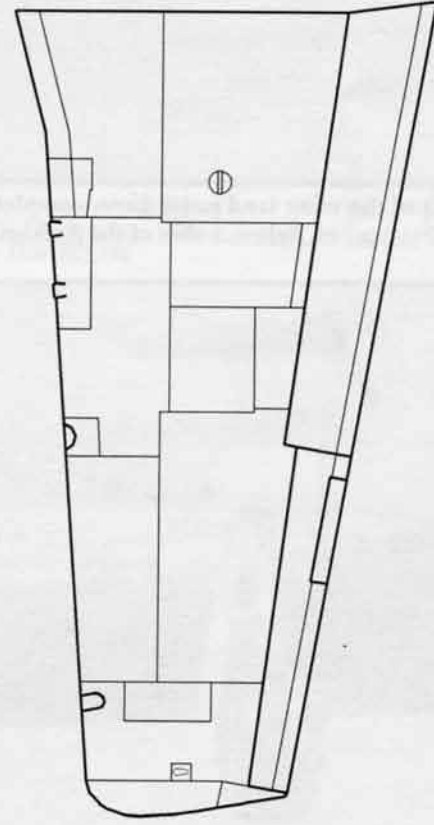

MUSTANG MK. I UPPER LEFT WING  
1/48 SCALE

Figure 1: Early Mustang Wing Details

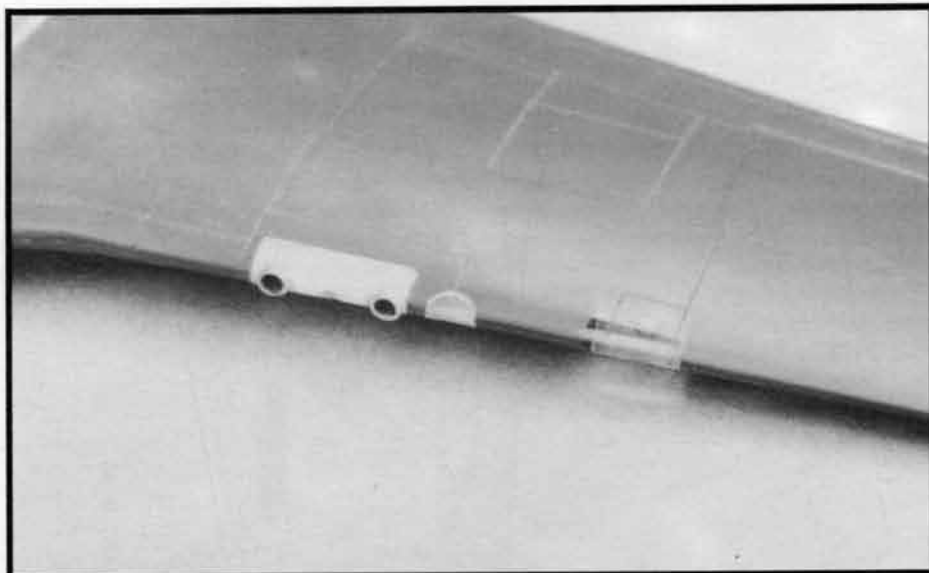

Above, modifications to the wing leading edge. Note the plexiglas block to represent the light, and how the scribed lines are well in from the edges of the block.

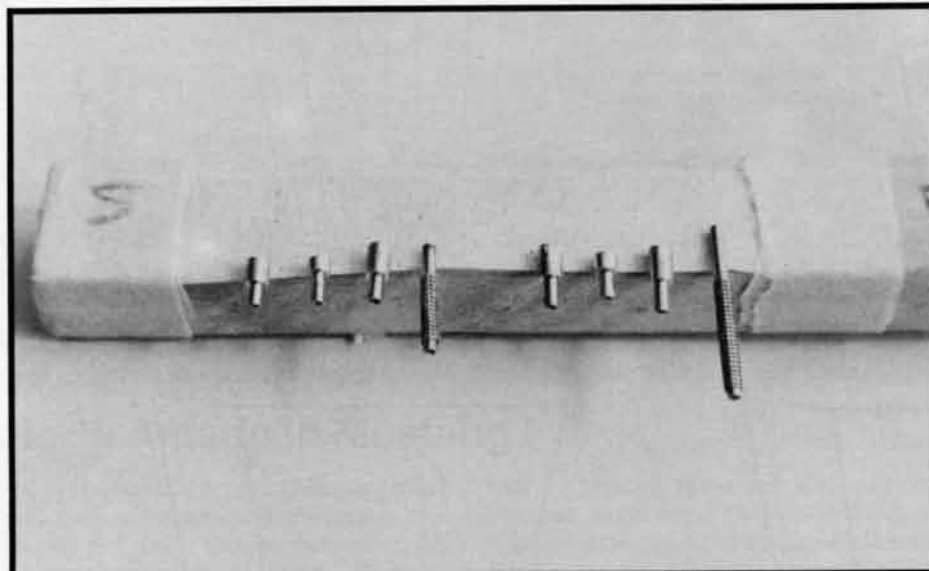

Above, details of the wing (and nose) guns, complete with tubular collars to centre them in their blast tubes. Below, a shot of the finished model show just how effective this can be.

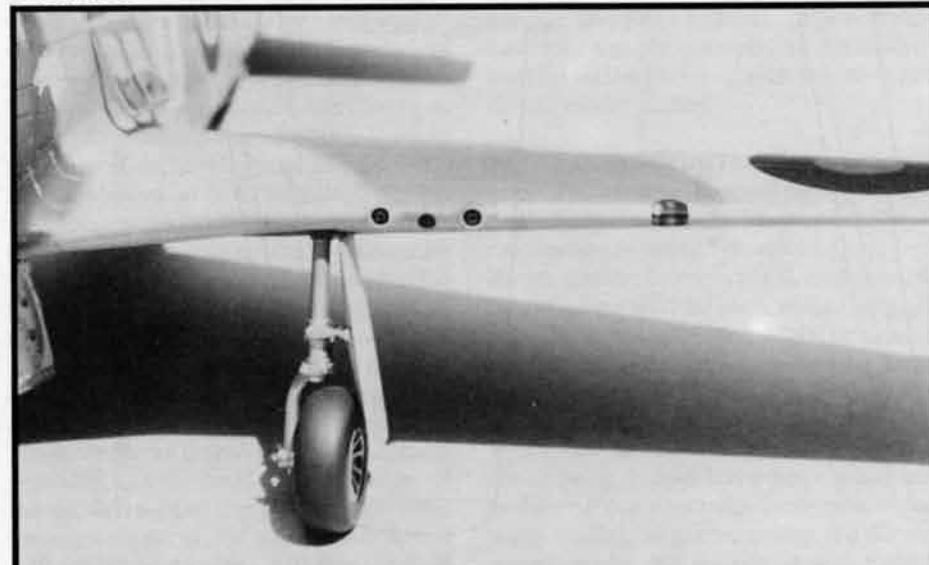

wings such as wheelwells.

At this point, you must decide if you are building an early or late Mustang I. Early machines were North American NA73's, serialled AG345 to AG664. Modifications were made to the second and third production batches, designated NA83 and serialled AL958 to AM257 and AP164 to AP263. All three batches are still called Mustang I's - the first batch is readily distinguished by the long floodlight lens (some references say gun camera) in the outboard leading edge of the left wing. If this lens is present, there is also a large rectangular panel immediately aft of it. As usual, it is important to try to get photographic references of the specific aircraft that you are building. The outboard floodlight / gun camera can be made in the same way as the landing light.

Now the shape of the wing leading edge can be restored by filing and sanding, in preparation for constructing the wing armament. The guns on a Mustang I are buried in the wing, but the ends of the barrels and the inside of the blast tubes are clearly visible. These can be represented with telescopic sections of tubing. Use small stainless steel tubing for the barrels, and fit them into short sections of slightly larger tubing. These short sections will provide support and spacing between the barrel and blast tube. Just in case any nitpickers are wondering, the difference in .30 and .50 calibre is indiscernible in photos of the real machine, so it is definitely not worth breaking out the micrometer the select the exact 1/48 barrel diameters. ("Exact modelling" is a contradiction in terms anyway.)

The new inboard and outboard guns will require blast tube fairings. Select brass tube with an outside diameter of 1/16" and an inside diameter slightly larger than the spacer tubes mentioned above. Start with a small pilot hole, then work your way up to 1/16" holes to accept the blast tubes. Secure these with epoxy, leaving a little bit protruding, then blend the contours into the wing leading edge with filler. Slightly round off the ends of the tubes so that no sharp edge remains. The .30 cal gun in the centre is staggered below wing centre. It should also have a fairing, much less pronounced than the other guns, but it would be quite difficult to pull off in this scale and it is not noticeable in most photos of Mustang I's anyhow. A smaller hole is therefore required for the centre gun, the same size as the inside diameter of the blast tube. The gun barrels can be set aside and fitted after the model is painted.

On the underside of each wing, the new armament dictates filling the existing two shell ejector chutes, and cutting open three new ones. Some rescribing of the

upper and lower wing surfaces is required, mostly for the new armament door layout. Note that the Mustang I does not have the three lights on the underside of the outboard right wing. These are easily filled in.

#### NOSE AND FUSELAGE

The nose of the Mustang I has two .50 cal. guns in the cheek positions. The left barrel protrudes further than the right, and both barrels have perforated cooling jackets. Again, use stainless steel tube for the barrels and wrap fine photetched mesh around the barrel to represent the jackets. (see photo at left) The mounting of the guns will be much easier with the nose halves assembled but not attached to the fuselage. Drilling holes at the shallow angle required is best done with a couple of steps. First drill a pilot hole roughly perpendicular to the nose surface. Then open up the hole by re-drilling and filing at progressively shallower angles with the goal of achieving a hole parallel to the fuselage centreline. This will appear as a long trough when viewed in profile. The plastic is too thin to support the gun barrels by itself, so a larger brass tube with one end bevelled should be glued into the inside of the cowl immediately behind the hole. After the model is painted, insert the gun in the brass tube to the depth required. Here's a tip to very quickly achieve very accurate alignment of the nose gun. When installing the brass support tube, the aft end of that tube must be somehow fixed to the inside of the fuselage for strength. Use a round piece of .020 styrene, and drill an eccentric (off-centre) hole the same diameter as the outside of the support tube. Slide the end of the brass into the hole in the disc, then, using five-minute epoxy, attach the tube and disc to the inside of the cowl. Then slide a long tube or rod of smaller diameter through the brass tube. The idea behind using a long length is that minor angular misalignments become readily apparent to the average eyeball, even late at night. The use of epoxy gives plenty of working time to rotate and slide the disc until the assembly is aligned.

The intake of the carburettor duct has a pronounced downward slope if mounted as-is from the kit. A tapered shim under the intake will fix this. To prevent "see-through" in the duct, paint a 1/4" wide strip of styrene flat black, then attach it along the inside seam of the nose halves before attaching the kit nose. The shape of this duct on the Mustang I has been the subject of some debate among modellers. The kit intake has straight sides when viewed from above, but some photos suggest that there should be slight bulging in the centre, while others are

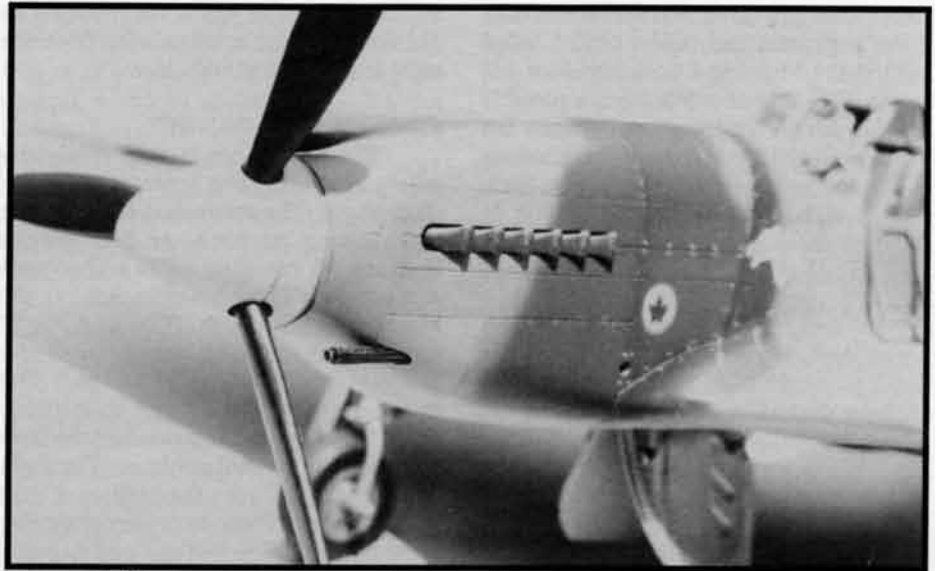

Follow the instructions on this page and your cheek guns can look this good!

**Figure 2: Installation of Cheek Guns**

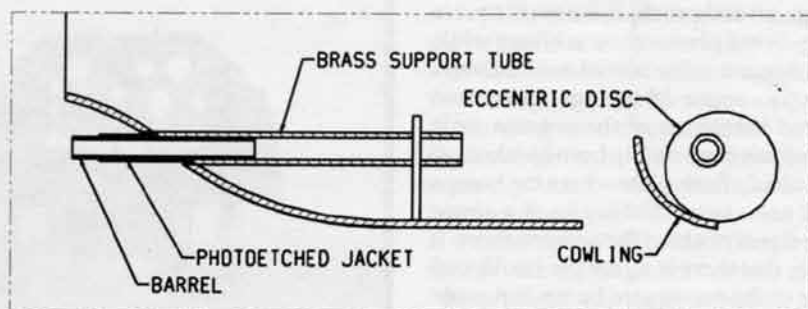
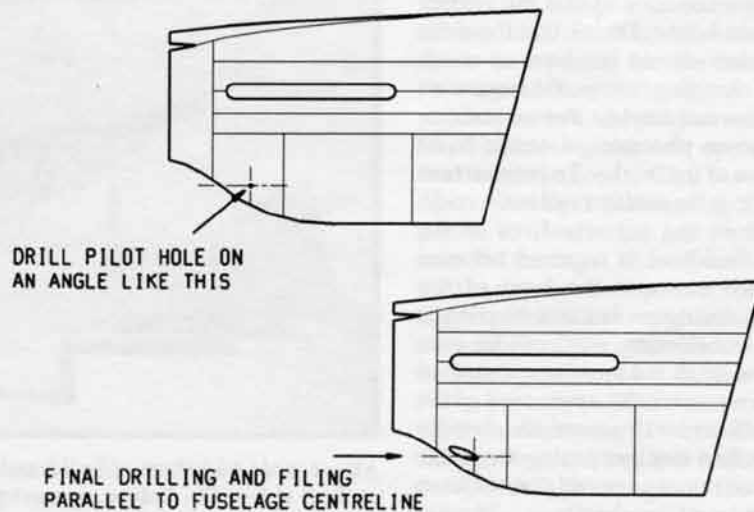

clearly straight sides. The P-51A and A-36 have a pronounced "Coke bottle" bulge which the Mustang I certainly does not have. One reference mentions a possible intake design modification between the NA73 and NA83 versions of the Mustang I. Check your own references, but there seems to be insufficient information to warrant making any changes.

The last item on the nose is the shape of the propeller. The kit prop is paddle bladed and appears accurate for a P-51A or an A-36. However, the Mustang I has more pointed blades. Simply remove plastic from the trailing edge of the blade from about halfway along the blade out to the tip. While you have the sanding sticks handy, the prop blades could also use some thinning down, particularly towards the tips. On the underside of the fuselage, the radiator intake has an inaccurate step at the lip. This needs to be built up with filler, filling in the circumferential panel line. The intake door should extend forward all the way to the intake lip. Simply extend the scribed lines. The shape of the radiator intake is the only area where I question the accuracy of this kit. When viewed from below, I think that the sides of the intakes should not have so much taper, but changing this would require an entirely new rad intake. Before installation, cut some photoetched screen to fit into the rear of the intake. To prevent "see through" from the radiator exit to the cockpit, and from the tail wheelwell to the cockpit, a bulkhead is required between the radiator exit and the front of the wheelwell, and some radiator ducting is required. Considering what can be seen through the small rad openings, a sheet of styrene to represent the upper wall of the duct is sufficient. However, the detailer can have a field day by opening the intake and exhaust doors to reveal the radiator, the ducting and mechanisms. Internal structure can also be added to the tailwheel well.

Photo reconnaissance Mustang I's had a variety of small bumps and blisters on the fuselage. On the left side of the fuselage, aft of the cockpit, is a small square fairing. Some photos show a blister while others suggest some sort of exhaust vent. Similarly, some Mustangs have two louvered bumps aft of the antenna mast while others have clearly been blanked off with a nearly flush plate where the bumps would have been. Others have a single blister directly behind the antenna mast. It appears that there is either the two dorsal bumps or the one square bump, but probably not both. Again, check your references for the specific aircraft you are modelling. For the antenna mast, a styrene or brass rod will look more to scale than

the kit mast. Note that some Mustang I's did not have the antenna wire from the mast to the vertical stabilizer.

### COCKPIT AND CANOPY

The kit interior is very nicely detailed, even including separate undercarriage levers. The conversion of an American Mustang interior to an RAF interior involves the compass, radio and oxygen equipment. The best reference on the Mustang I cockpit is the "Classic Aircraft" series (Reference 1). Make a new aperiodic compass from plastic sheet and rod. The compass looks like a large instrument, about 3-4" diameter, mounted on the floor ahead of the control column. The right cockpit wall includes the radio and oxygen equipment. Remove, replace or modify some of the black boxes and add a couple of levers to get the correct look. The left cockpit wall molding has what appears to

be two superimposed elevator trim wheels. Carefully remove the incorrect one. Add small levers for the radiator and flap controls, as well as the cockpit lamp. Before attaching the sidewalls, test fit them with the cockpit floor and fuselage halves. This will ensure that everything in this area will line up later!

The kit instrument panel is molded in clear plastic with raised instruments. An instrument decal is provided so the modeller has the option of gluing the decal behind the clear panel, or painting and drybrushing the panel. However, by using only these kit parts, a much more effective panel can be created without a lot of effort. Carefully drill out all instruments and clean up with a small circular file so that only the raised bezel remains. Then, thin down the panel by sanding down the rear face until a realistic scale thickness is achieved, say about .015". After

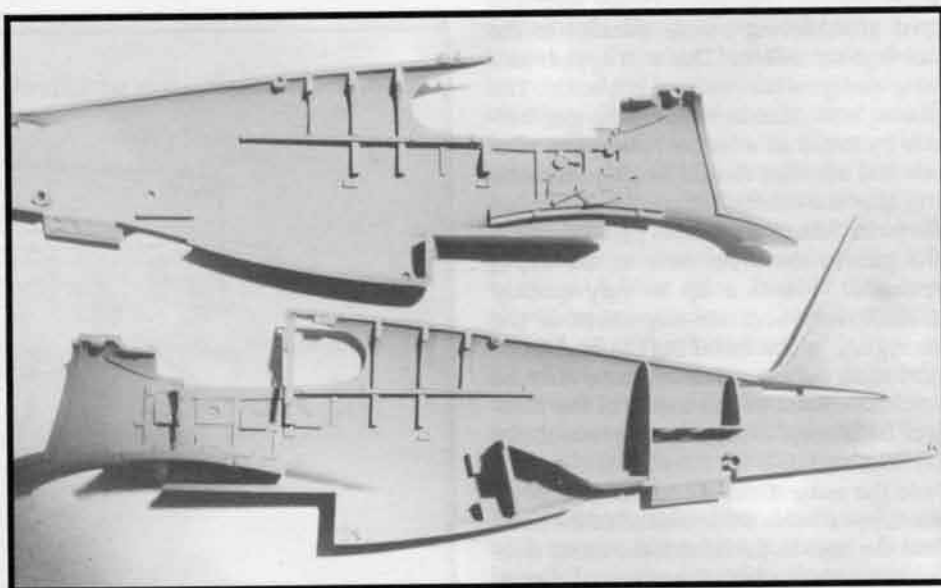

Above, note additions of bulkheads, rad duct, camera support shelf rails and mods to cockpit sidewalls. Below, armour plate and instrument panel.

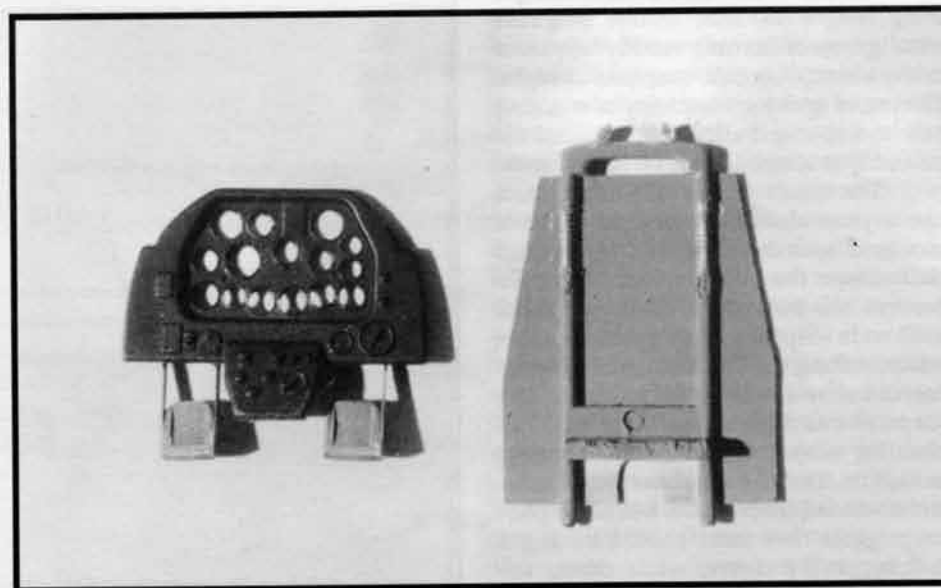

spraying the panel flat black, glue the decal from behind. Highlight the bezels with a silver pencil crayon. The gloss finish of the decal makes applying dabs of clear gloss unnecessary. The rudder pedals are also molded in clear. The mounting is quite thick, but the pedals themselves are usable. Remove the supports and replace with styrene strip.

Surprisingly, the kit does not include cockpit armour plating. There should be a large plate behind the seat frame and a smaller plate behind pilot's head, mounted to the A-frame. Make these from .015" styrene sheet. The last details to add to the cockpit are a handle below the right side of the seat (for seat adjustment?) and a seat harness, probably the American style harness. There is some debate on the type of control column used in Mustang I's, but the majority of photos show the standard American style pistol grip, and not the

RAF spade grip as reported in some references. There should probably be a second trigger of some sort for the camera. The cockpit colour is probably U.S. Interior Green; that's the somewhat yellowish green, not RAF interior green-grey.

The camera is located behind the armour plate where the radio normally resides. It is mounted on a sheet metal shelf which slides back into the fuselage. The radio is relocated on the same shelf aft of the camera. If you have the Mustang IA kit, most of this already exists in the kit, but if you pounced on the P-51 kit before the Mustang IA release, as I did, then you will need to do the following yourself. Make the shelf from .015" styrene and punch out four large lightening holes. For the support rails, use .030" x .030" styrene strip with a groove scribed down the middle to represent the cam follower track. Slice the radio from the kit shelf and glue it to the

new camera shelf. The camera itself must be built from scratch with styrene blocks, sheet and tube. Use a drop of Humbrol Clear to represent the lens. The lower radio shelf with the oxygen bottle can be used straight from the kit but it will be difficult to see in the completed model.

The canopy is the poorest part of the Accurate Miniatures kit - it is thick with a pebbly finish and a lot of optical distortion. However, I think it is easier to sand and polish the kit canopy than to try to fit an aftermarket vacuformed canopy, particularly for those half round rear windows. The system of polishing cloths will make the clean-up fairly quick and easy. Both the inside and outside surfaces require this procedure. Start with about 400 grit sandpaper with lots of water to remove the canopy frames and the rough finish. Be careful not to scratch deeply. The result should be a smooth but translucent finish. Then use wet 600 and 2000 sandpaper to improve the finish. Start with the 3200 grit polishing cloths, progressing to the final 12000 grit. If there are no scratches, use polishing paste such as Tamiya's to bring up the shine, then wash off any residue. The left side window needs an opening for the camera lens. Drill a hole then file to shape. Note that virtually no two Mustangs are alike in this respect, since the window openings were field modifications. Glue the side windows with super glue leaving the outside surface of the window just slightly raised from the fuselage. There is sufficient ventilation through the open cockpit to avoid fogging from the super glue fumes. Sand the outside of the side window to match the fuselage contours, then repeat the polishing procedure. The reason for polishing the outside twice is that it is difficult to tell how well the inside is polished while the outside is still rough. If the canopy is to be displayed open, cut the main canopy section. When installing the canopy, a shim may be required on the windscreen to get all of the sections to line up.

#### ASSEMBLY

Before assembling the fuselage, check the fit of the lower radio deck, and trim as necessary to facilitate a tight fit of the fuselage halves. To achieve a good fit of the wing root, a spreader bar between the fuselage halves at the root may be necessary. Also, wedge shims can be fitted between the upper and lower wing halves at the root to make the airfoil shape match that of the fuselage root more closely. Before gluing any major assembly, check the wing and nose fit. With care, the nose can be made to fit so closely that no filler will be required, saving a lot of filling and rescribing. The model is now ready for masking, priming and painting. (Fig. 14)

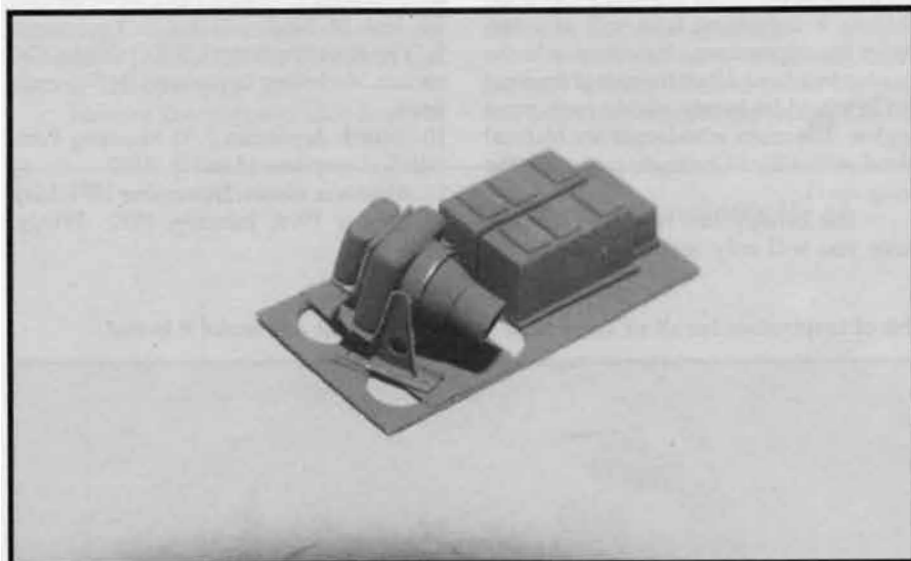

Above, the camera on its new shelf and below, in its new home. Note how thin the polished canopy is around the edges of the camera cutout.

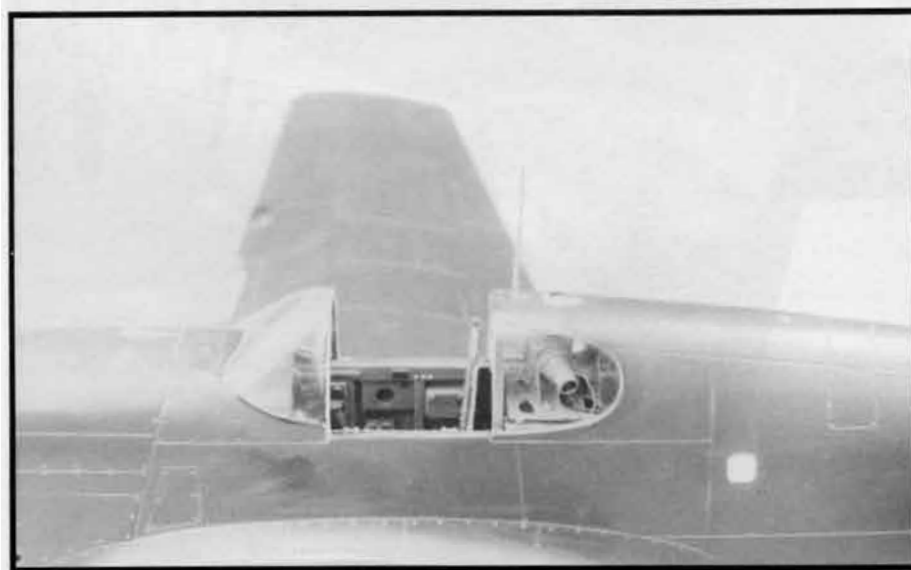

**MARKINGS**

I had decided from the start of this project to build the well known Mustang I of 414 Squadron, RCAF, AM251/O. After I had started, it became apparent that this was a good choice as I learned that detailed information and the IPMS Canada D-Day decal sheet were to become available for this particular aircraft. There is very little I can add to Steve Sauve's excellent article in RT, Vol. 24, No. 1, except perhaps a little more speculation on the multi-toned colour scheme. Note that both the Dark Green and Grey on the fuselage are lighter in tone and appear uneven from the cockpit back to the Sky fuselage stripe. I believe that this may be from the re-paint that many Mustang I's in the Second Tactical received when full squadron codes were replaced with a single aircraft identification letter. I finally decided on a scheme based on RAF Dark Green and Mixed Grey over Sea Grey Medium, using several different shades of each to cover the fresher and the more worn appearance of various parts of the aircraft. Extracolour paints were used throughout, adding parts of white, grey or blue for these various tones. Mixed Grey was primarily Sea Grey Medium with some Black added - I thought that the RAF specification of a 7:1 mix looked too light for this particular aircraft,

so I went a little bit darker. Weathering was accomplished initially with pastels and paint chipping was mostly done with a very sharp silver pencil crayon. After these photos were taken, I elected to add a dirty brown wash to many of the panel lines, and airbrushed some exhaust staining using a dirty brown-grey. The IPMS Canada decals are printed by the Ministry of Small Aircraft Production and are excellent. They easily snuggle into even the tiniest surface detail with the use of a little Solvaset. To make them look more "painted on", spray the decals with some clear gloss before applying the final flat overcoat.

**FINAL ASSEMBLY**

The kit provides the option of round or weighted tires, all with very nice tread detail. However for a Mustang I, all tread, including the tailwheel tire tread, must be sanded off. The scissors on the main landing gears struts could use some thinning. Drilling a lightening hole will also improve the appearance. If desired, a brake line can be added down the rear of the strut but it would be barely visible from most angles. The main wheelwells are Natural Metal with a Zinc Chromate rear wall (the wing spar).

The canopy can now be attached. Since you will only see the inside of the

open side panel, only the inside and the edge of this part of the canopy frame need to be painted. Further detail such as the sliding window mechanism can be added at this point. Finally, install the guns and prop, and you are ready for your next project! Happy modelling!

**REFERENCES**

1. "P-51 Mustang, Classic Aircraft No. 3", Ray Cross & Gerald Scarborough, 1973.
2. "Camouflage & Markings, RAF Northern Europe 1936-45, N.A. Mustang".
3. "P-51 Mustang in Action" (#45), Squadron/Signal Publications, 1981.
4. "P-51 Mustang in Colour", Squadron/Signal Publications, 1982.
5. "Mustang at War", Roger Freeman, 1974.
6. "First Blood for the Mustang", Ralph Clint, CAHS Journal, Spring 1992.
7. Canadian Forces / RCAF Photo PL 19833, via Steve Sauve.
8. "Mustang I, AM251/O", Steve Sauve, RT, Vol. 24, No.1.
9. "The First Mustangs", Bill Coffman, Canadian Modelling Exposition '94 Souvenir Book.
10. "North American P-51 Mustang Portfolio", Aeroplane Monthly, 1987.
11. Airpower issues: November 1971, May 1972, May 1976, January, 1977 Wings, June 1976

A last look at Cam's Mustang ... a bit of inspiration for all of us on how to take a nice kit and make it better.

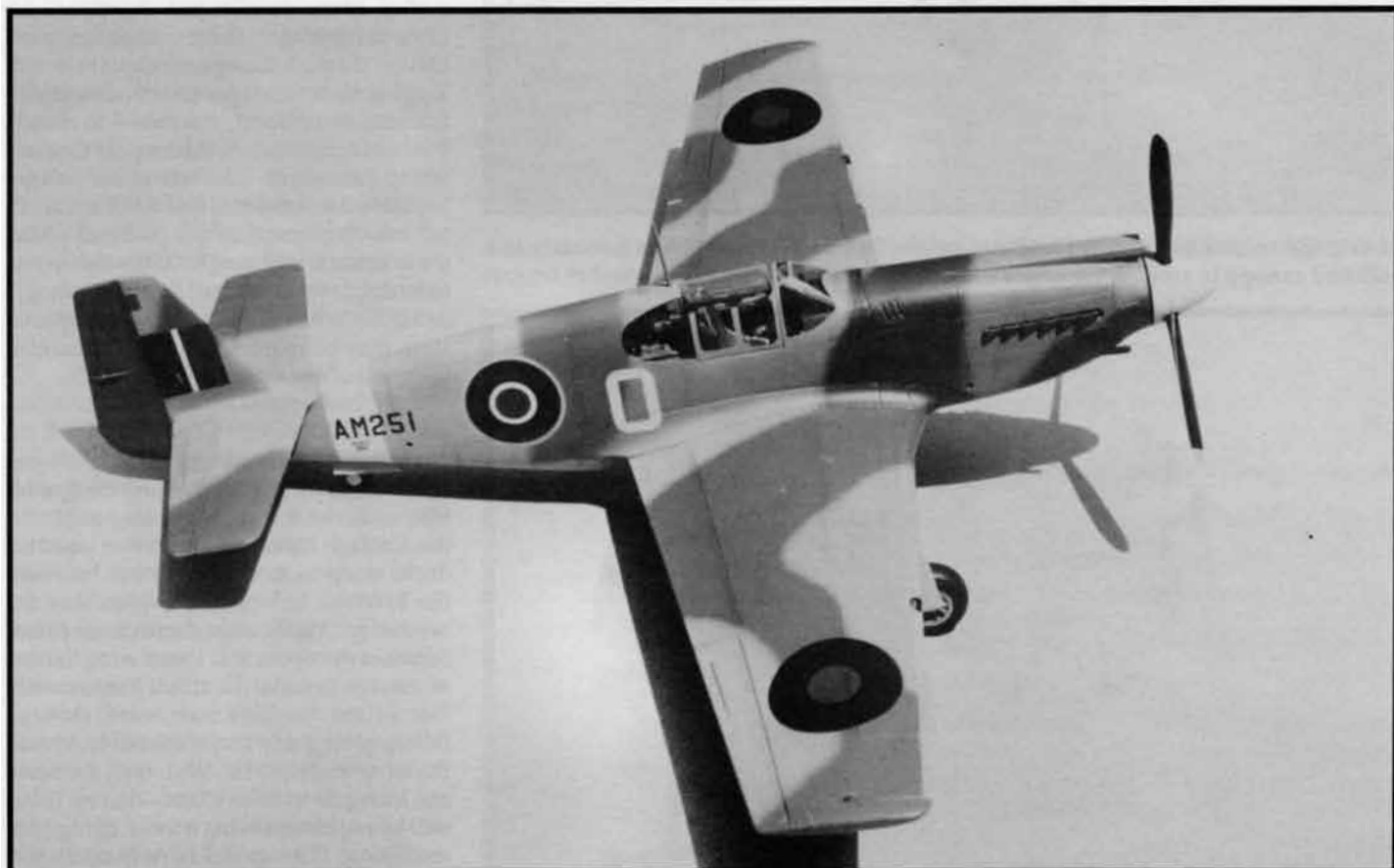

# RT Our Magazine



We hope you've enjoyed this brief look at what the members of IPMS Canada have been producing for our magazine. Today **RT** is a quarterly publication, in English, containing 36 pages of photos, drawings, kit reviews, model building and conversion articles, hints-n-tips, and other items of modelling interest. All content is provided by the members, for the members. We've also occasionally sent out a free special bonus item, such as a decal sheet, with the magazine.

IPMS CANADA

## beaverRTales

[www.ipmscanada.com](http://www.ipmscanada.com)

Recently IPMS Canada started sending the members another publication. This is an e-newsletter called *beaverRTales*, which arrives in their email as a PDF document. It is sent in the periods between **RT** issues and unlike **RT**, it is more 'newsey'. Here you'll find such things as kit, accessory and book reviews, news from various local chapters, information on new model kits, small build and photo articles (as opposed to **RT**'s more detailed material), hints-n-tips, photos of members' latest creations, quizzes, and whatever else the members send in. The newsletter will keep you up to date on what's happening in IPMS Canada, and the rest of the modelling world.

---

If you'd like to find out more about IPMS Canada, just visit our website at [www.ipmscanada.com](http://www.ipmscanada.com). There you can find out more about our Branch and what we provide, see some pictures of our members' models, and even check out our 'Fun Page'. If you like what you see, you can join right there online!

